

## Maswell 5G mmwave Horn Antenna

### AN.Horn.5G.mmwave.26.40.WR28

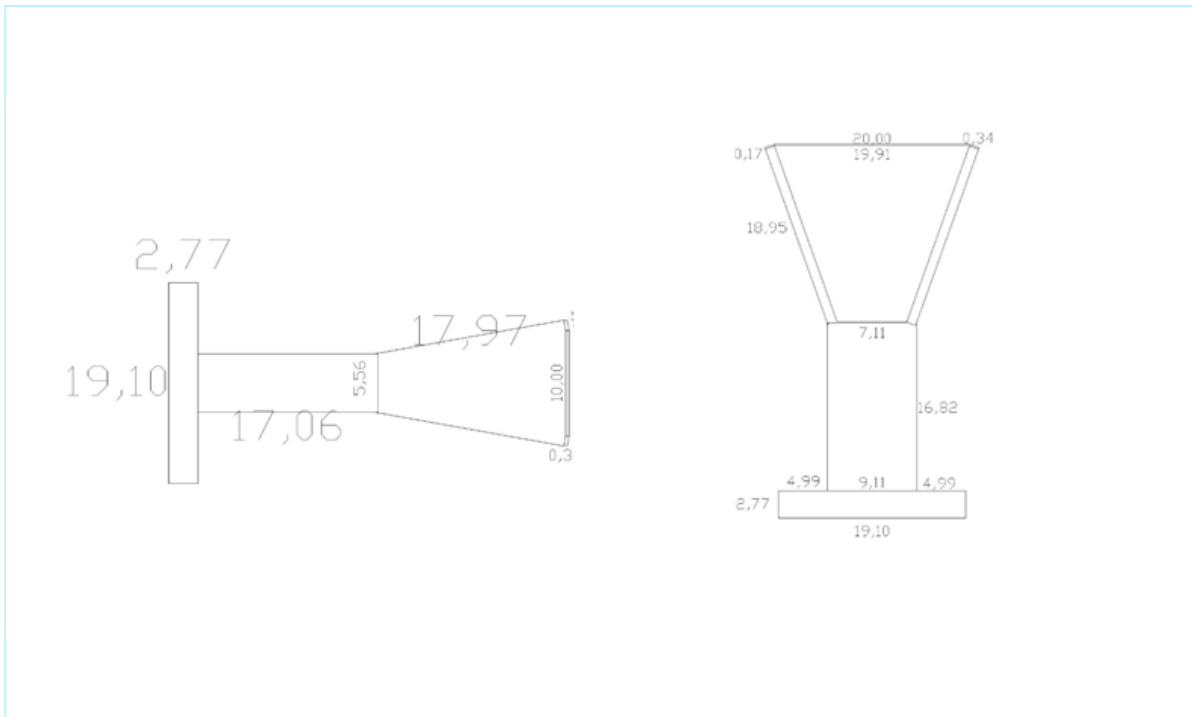

### Mechanical dimension





## Maswell 5G mmwave Horn Antenna

### AN.Horn.5G.mmwave.26.40.WR28

## Specifications

Item		Specifications
Antenna	Center Frequency	26.5~40GHz
	Polarization	Linear
	Gain	13dBi
	V.S.W.R	<1.2
Mechanical	Dimension	21.8mm*19.1mm*39.3mm
	Cable	N/A
	Connector	WR 28 flange
	Mounting Method	Screw
Environmental	Environmentally Friendly	ROHS Compliant

## Maswell 5G mmwave Horn Antenna

### AN.Horn.5G.mmwave.26.40.WR28

S11

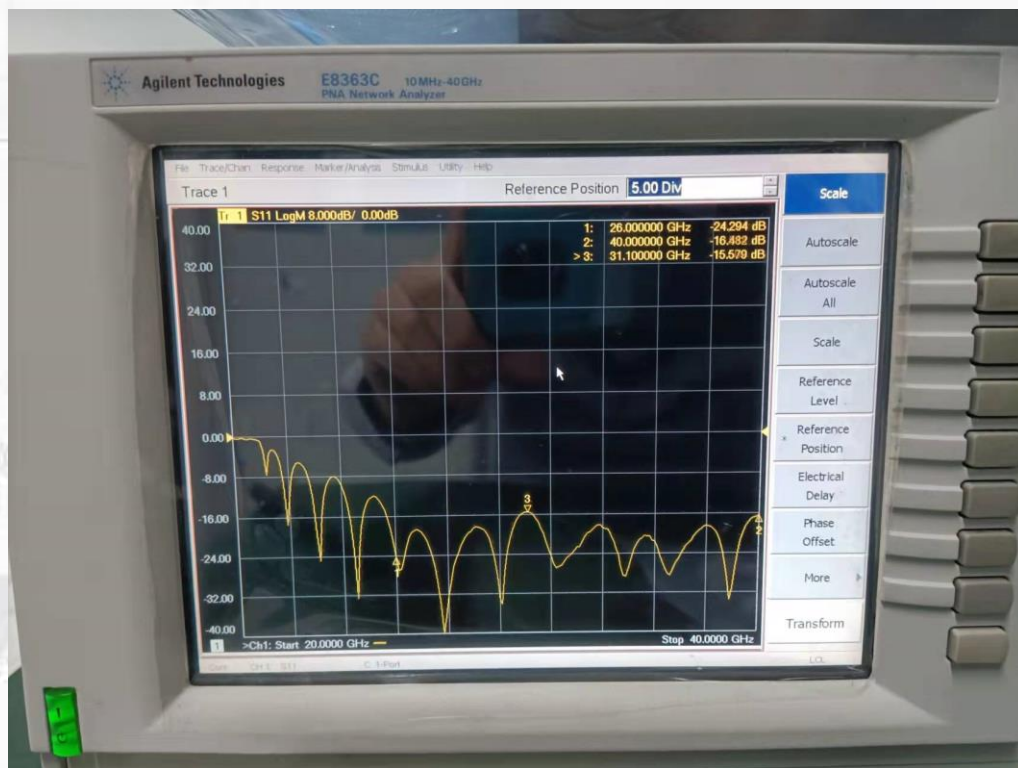



# Maswell 5G mmwave Horn Antenna

## AN.Horn.5G.mmwave.26.40.WR28

### VSWR

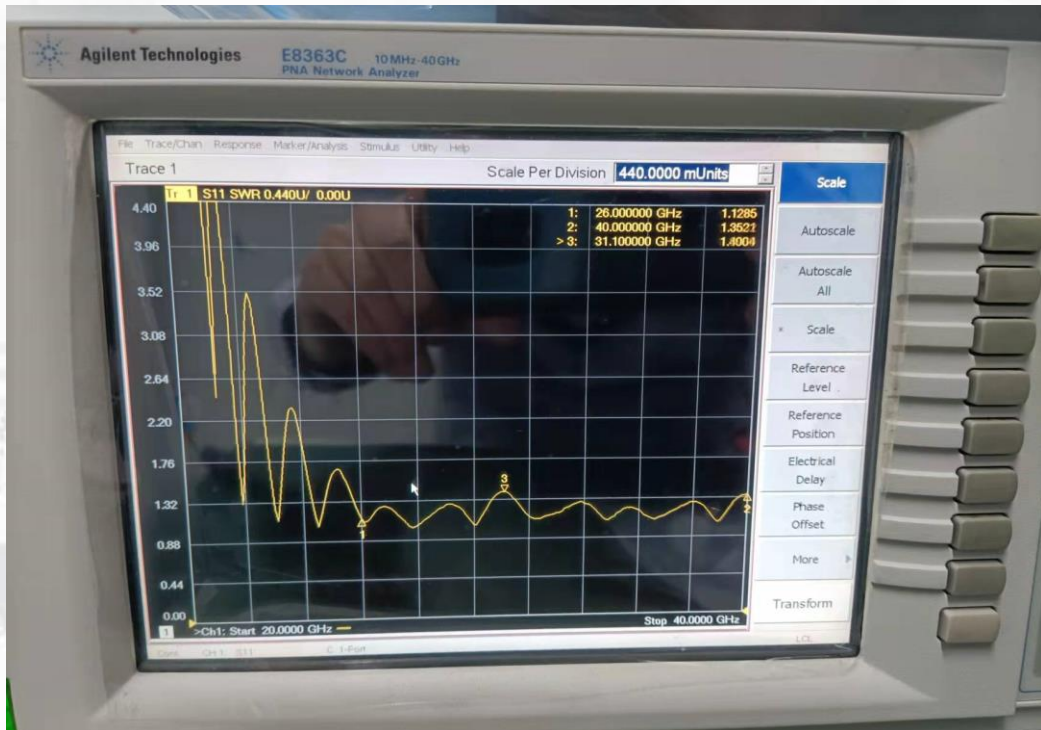

## Maswell 5G mmwave Horn Antenna

### AN.Horn.5G.mmwave.26.40.WR28

## Measured Radiation Pattern

Lower band 27GHz

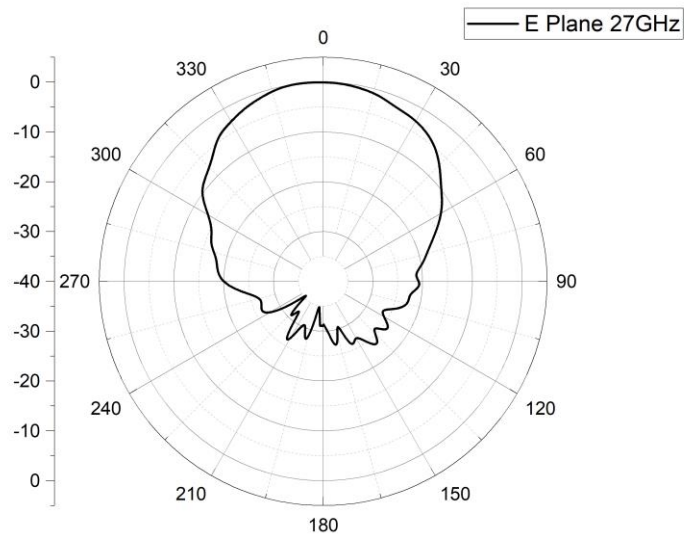

E plane

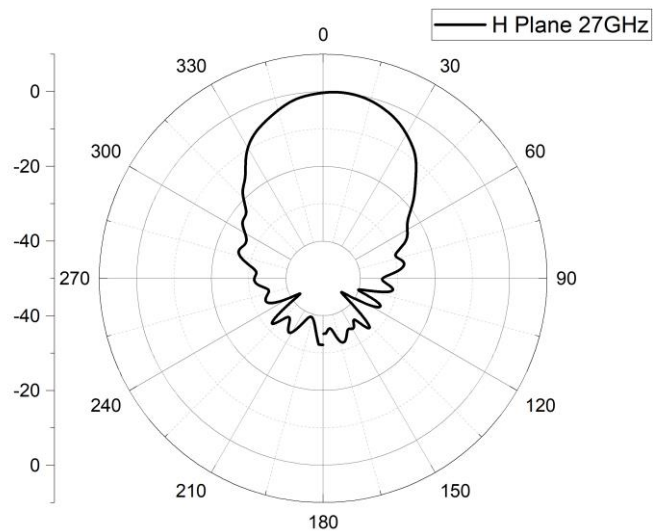

H plane

## Maswell 5G mmwave Horn Antenna

### AN.Horn.5G.mmwave.26.40.WR28

## Measured Radiation Pattern

Medium band 32GHz

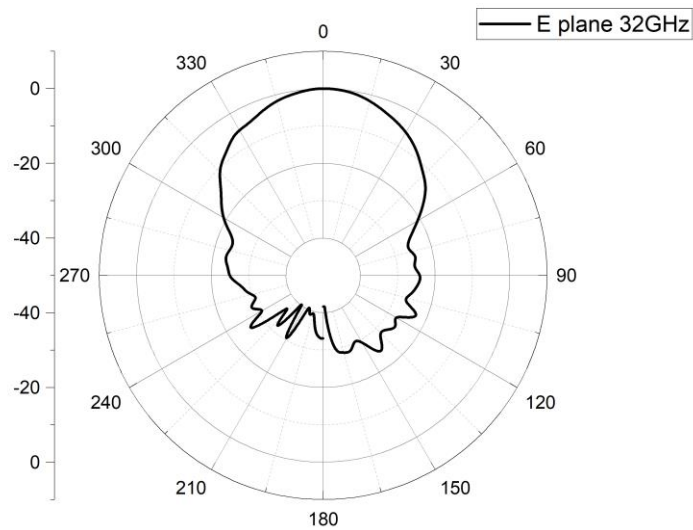

E plane

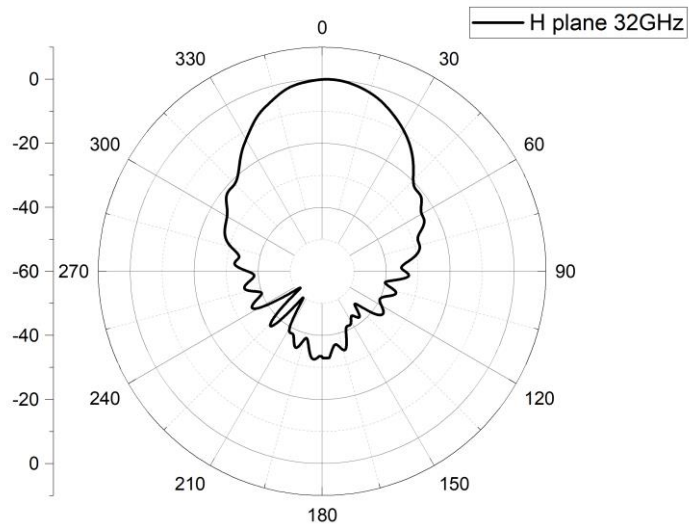

H plane

## Maswell 5G mmwave Horn Antenna

### AN.Horn.5G.mmwave.26.40.WR28

## Measured Radiation Pattern

Higher band 37GHz

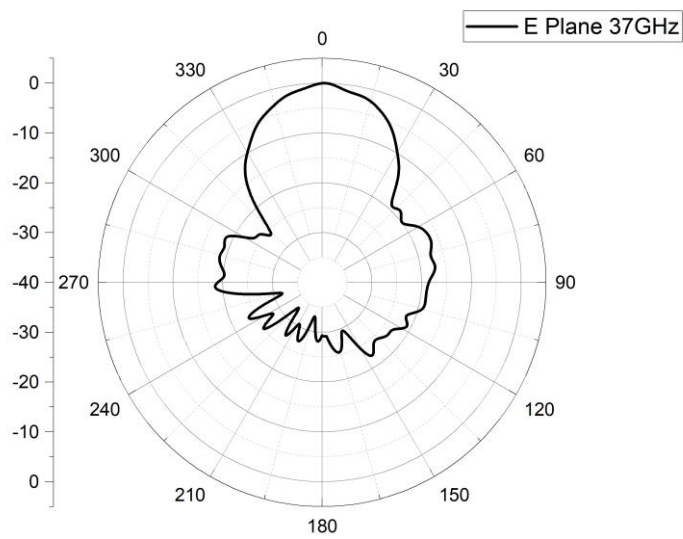

E plane

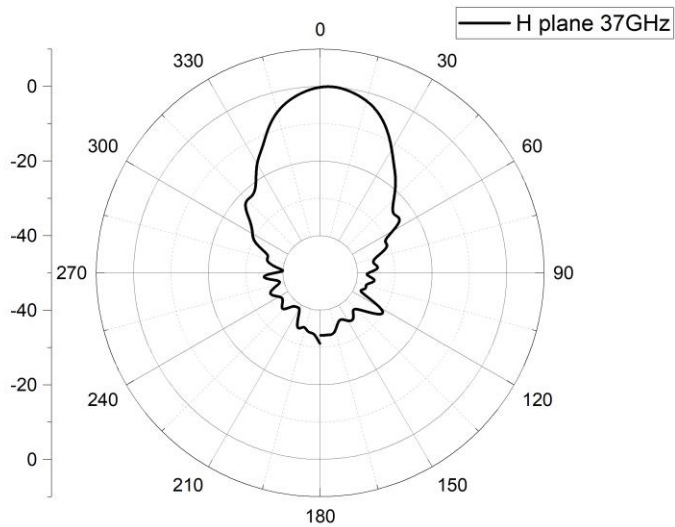

H plane

## Maswell 5G mmwave Horn Antenna

### AN.Horn.5G.mmwave.26.40.WR28

### Measured Gain Performances

Frequency(GHz)	Gain (dBi)
26	13.355
27	14.485
28	15.4
29	14.55
30	13.85
31	13.39
32	13.91
33	14.42
34	14.59
35	14.485
36	13.8
37	14.09
38	12.26
39	12.45
40	11.83