

Maswell 5G 4X4 MIMO Antenna Screw Mount IP67

AN_Master_Cubic-4C

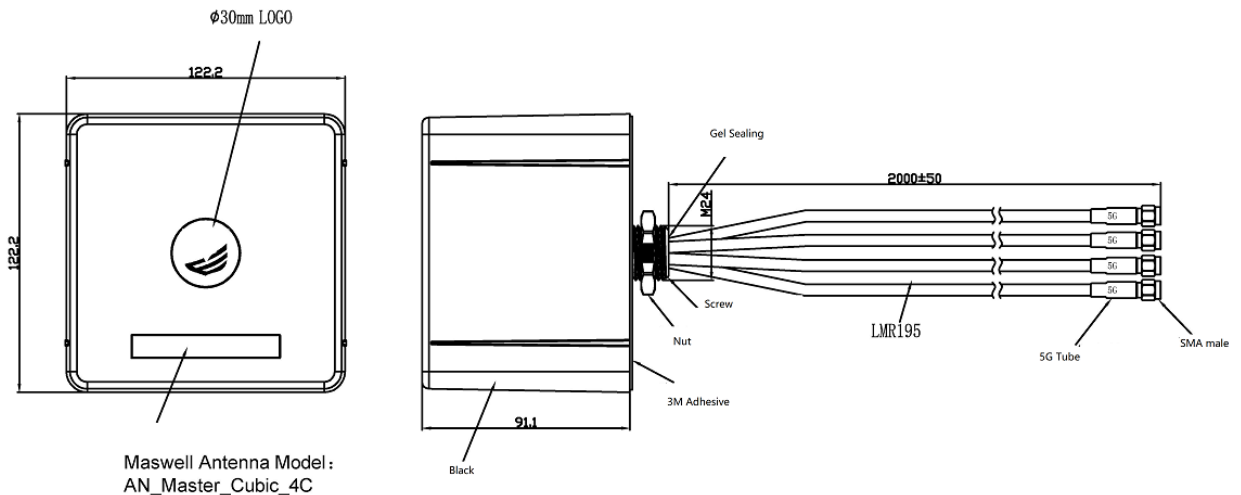

Schematic Picture



Maswell 5G 4X4 MIMO Antenna Screw Mount IP67

AN_Master_Cubic-4C

Specifications

Item	Specifications	
Antenna 1: 5G/4G LTE/WiFi6E/UWB	Frequency Range	600MHz~8.0GHz
	Polarization	Linear
	Gain	Up to 6.0dBi (20cm Cable Length)
	V.S.W.R	average 3.0
	Efficiency	>50%
Antenna 2: 5G/4G LTE/WiFi6E/UWB	Frequency Range	600MHz~8.0GHz
	Polarizatio	Linear
	Gain	Up to 6.0dBi (20cm Cable Length)
	V.S.W.R	average 3.0
	Efficiency	>50%
Antenna 3: 5G/4G LTE/WiFi6E/UWB	Frequency Range	600MHz~8.0GHz
	Polarizatio	Linear
	Gain	Up to 6.0dBi (20cm Cable Length)
	V.S.W.R	average 3.0
	Efficiency	>50%
Antenna 4: 5G/4G LTE/WiFi6E/UWB	Frequency Range	600MHz~8.0GHz
	Polarizatio	Linear
	Gain	Up to 6.0dBi (20cm Cable Length)
	V.S.W.R	average 3.0
	Efficiency	>50%
Mechanical	Dimension	121mm *121mm*91mm
	Cable	LMR195 1m or Customised
	Connector	SMA male
Environmental	Operating Temperature	-40°C~+85°C
	Waterproof Grade	IP67
	Relative Humidity	Up to 95%
	Vibration	10 to 55Hz with 1.5mm amplitude 2hours
	Environmentally Friendly	ROHS Compliant

Maswell 5G 4X4 MIMO Antenna Screw Mount IP67

AN_Master_Cubic-4C

S11 Reflection Coefficient

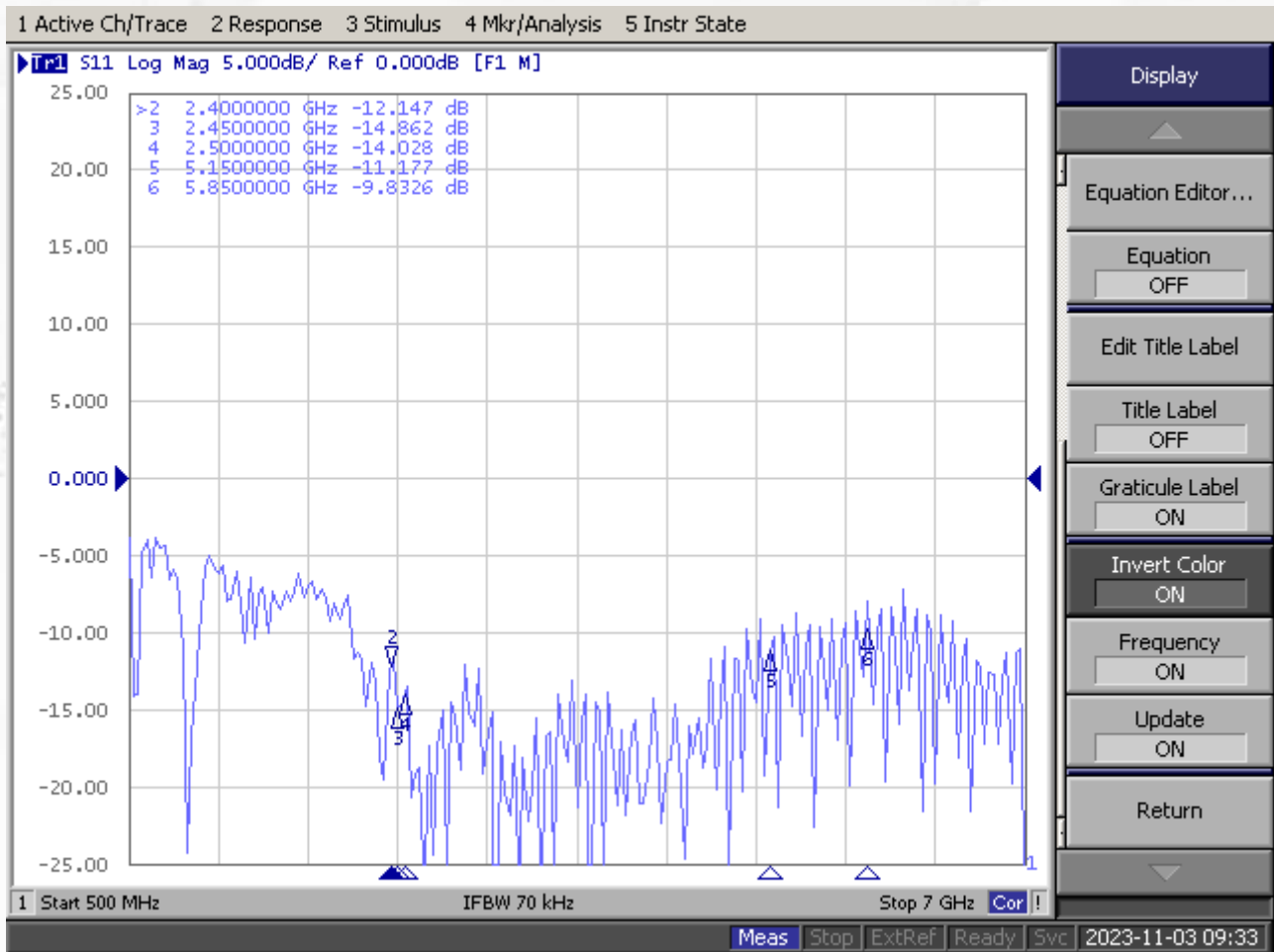

Maswell 5G 4X4 MIMO Antenna Screw Mount IP67

AN_Master_Cubic-4C

Isolation

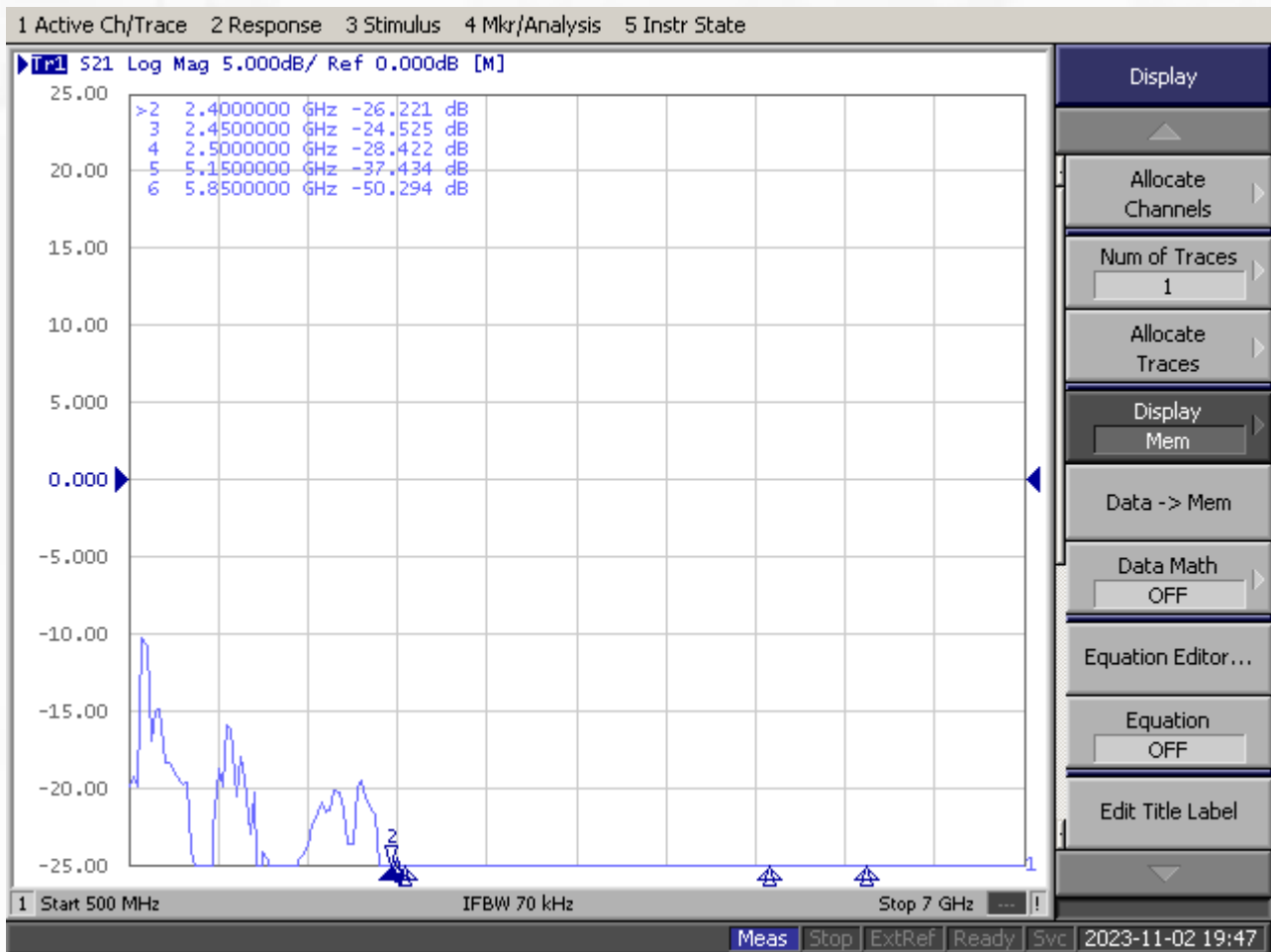

Maswell 5G 4X4 MIMO Antenna Screw Mount IP67



Radiation Pattern 900MHz

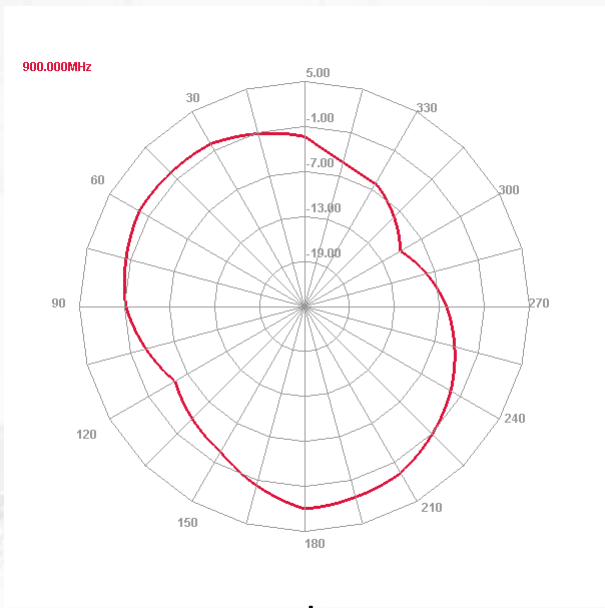

E plane

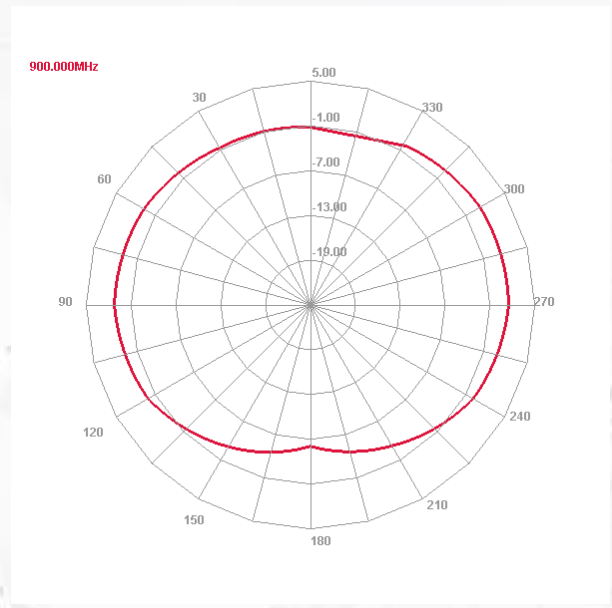

H plane

2400MHz

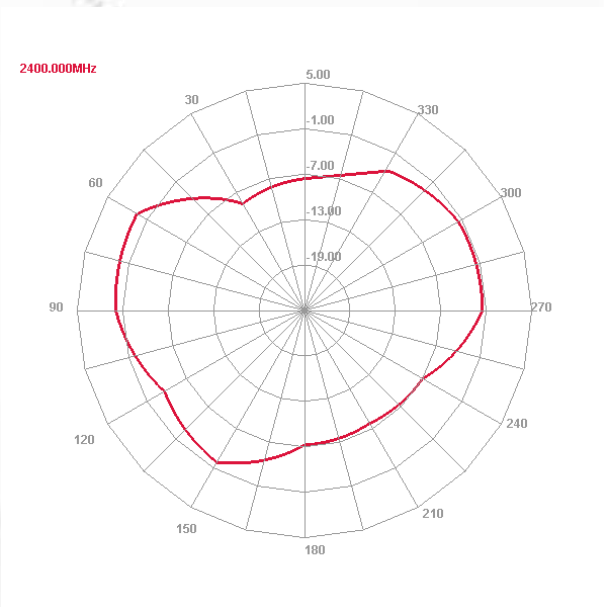

E plane

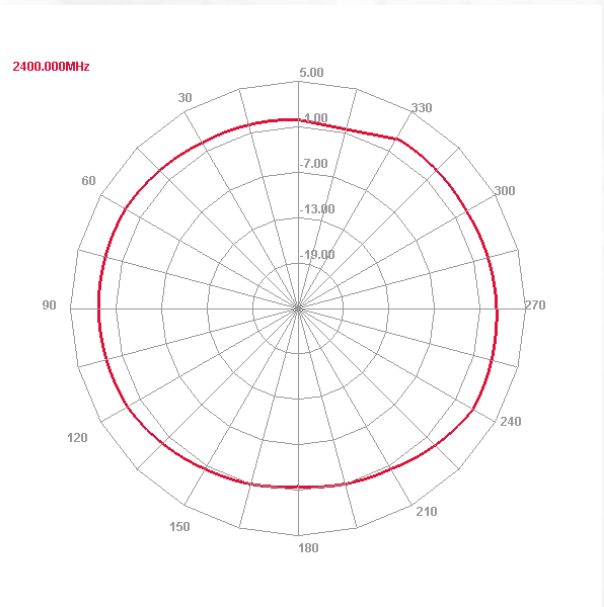

H plane

Maswell 5G 4X4 MIMO Antenna Screw Mount IP67



Radiation Pattern 3500MHz

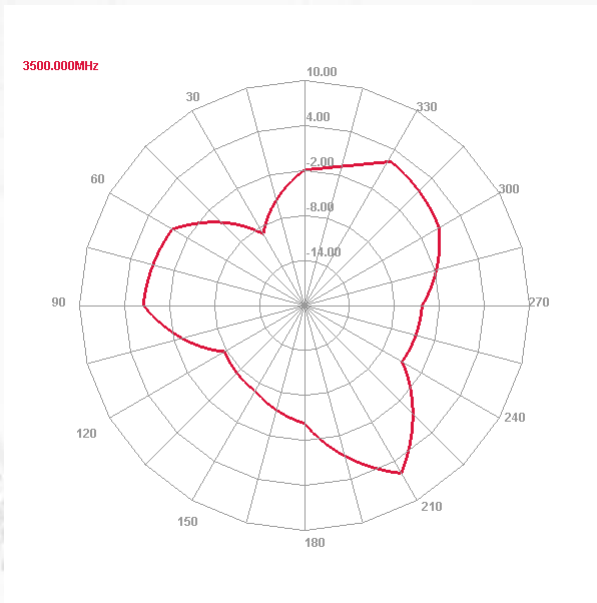

E plane

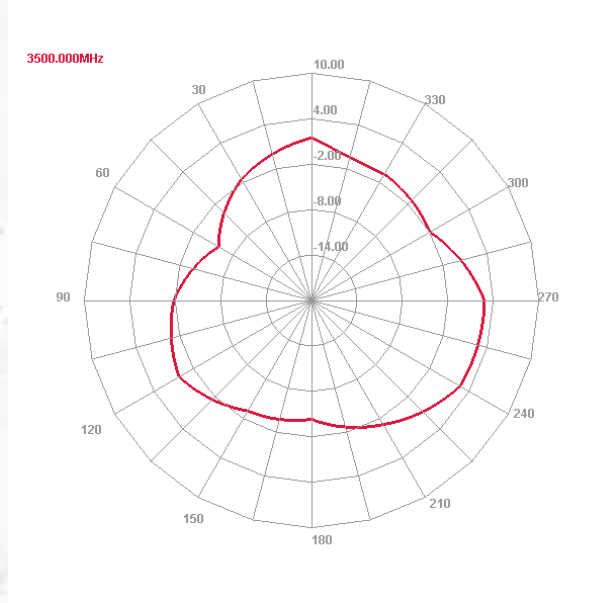

H plane

7100MHz

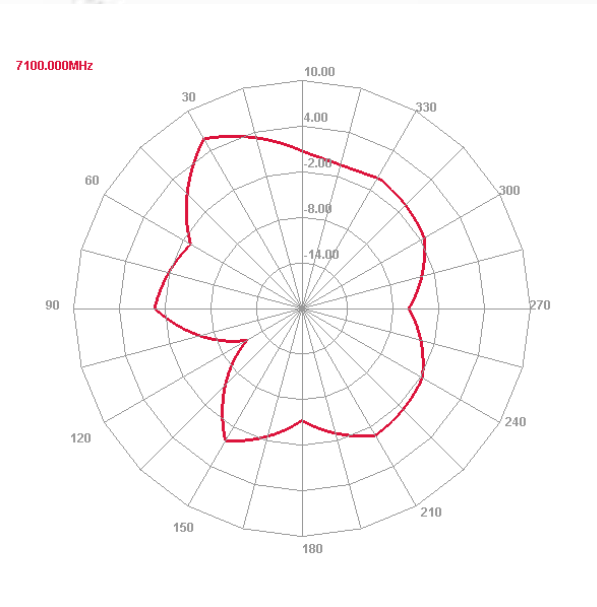

E plane

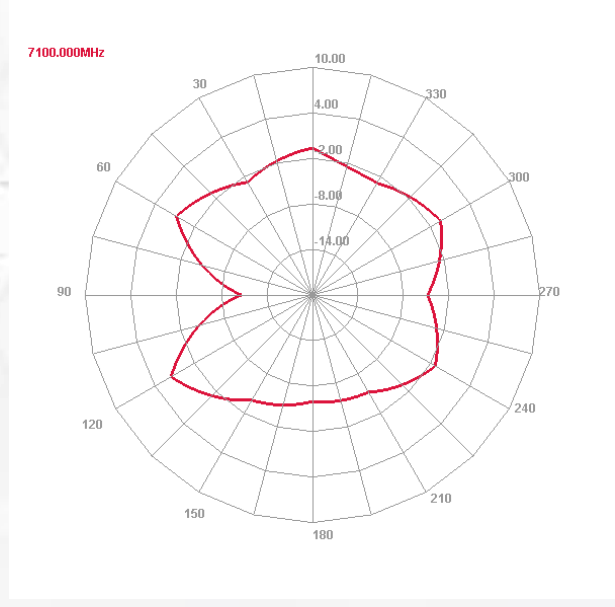

H plane