

Maswell Cellular 5G/4G 8X8 MIMO Antenna Screw Mount IP67 UV stabilized L Plate Mount

AN_Master_Cubic-8C-LP

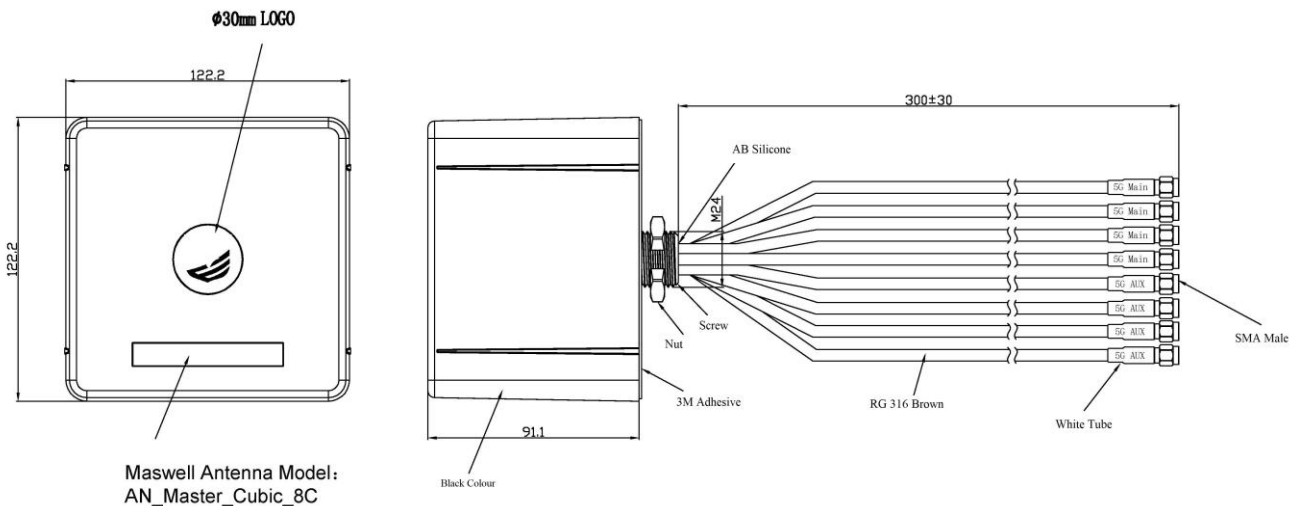

Schematic Picture



Maswell Cellular 5G/4G 8X8 MIMO Antenna Screw Mount IP67 UV stabilized L Plate Mount

AN_Master_Cubic-8C-LP

Specifications

Item	Specifications	
Antenna 1: 5G/4G/WIFI/Bluetooth Main	Frequency Range	600-8000MHz
	Polarization	Linear
	Gain	Up to 5.0dBi (20cm Cable Length)
	Radiation Pattern	Omni-directional
	V.S.W.R	average 3.0
	Efficiency	>50%
Antenna 2: 5G/4G/WIFI/Bluetooth Main	Frequency Range	600-8000MHz
	Polarization	Linear
	Gain	Up to 5.0dBi (20cm Cable Length)
	Radiation Pattern	Omni-directional
	V.S.W.R	average 3.0
	Efficiency	>50%
Antenna 3: 5G /4G/WIFI/Bluetooth Main	Frequency Range	600-8000MHz
	Polarization	Linear
	Gain	Up to 5.0dBi (20cm Cable Length)
	Radiation Pattern	Omni-directional
	V.S.W.R	average 3.0
	Efficiency	>50%
Antenna 4: 5G /4G/WIFI/Bluetooth Main	Frequency Range	600-8000MHz
	Polarization	Linear
	Gain	Up to 5.0dBi (20cm Cable Length)
	Radiation Pattern	Omni-directional
	V.S.W.R	average 3.0
	Efficiency	>50%
Antenna 5: 5G /4G/WIFI/Bluetooth AUX	Frequency Range	720-8000MHz
	Polarization	Linear
	Gain	2.0dBi
	Radiation Pattern	Omni-directional
	V.S.W.R	average 3.0
	Efficiency	>50%

Maswell Cellular 5G/4G 8X8 MIMO Antenna

Screw Mount IP67 UV stabilized L Plate Mount

AN_Master_Cubic-8C-LP

Specifications

Item	Specifications	
Antenna 6: 5G /4G/WIFI/Bluetooth AUX	Frequency Range	720-8000MHz
	Polarization	Linear
	Gain	2.0dBi
	Radiation Pattern	Omni-directional
	V.S.W.R	average 3.0
	Efficiency	>50%
Antenna 7: 5G /4G/WIFI/Bluetooth AUX	Frequency Range	720-8000MHz
	Polarization	Linear
	Gain	2.0dBi
	Radiation Pattern	Omni-directional
	V.S.W.R	average 3.0
	Efficiency	>50%
Antenna 8: 5G /4G/WIFI/Bluetooth AUX	Frequency Range	720-8000MHz
	Polarization	Linear
	Gain	2.0dBi
	Radiation Pattern	Omni-directional
	V.S.W.R	average 3.0
	Efficiency	>50%
Mechanical	Dimension	121mm *121mm*91mm
	Cable	LMR195 30cm + LMR 240 2meters
	Antenna Mount	L plate (Supplied) U bolt and Screw
	Connector	SMA male
Environmental	Operating Temperature	-40°C~+85°C
	Waterproof Grade	IP67 (EURO: EN 60529:1991+A1:2000+A2:2013+A C:2019 CHINA: GB/T4208-2017)
	Radome Material	ASA/ (UL Yellow Card)
	UV Exposure & Water Immersion	F1 (UL746C) UV stabilized
	Relative Humidity	Up to 95%
	Vibration	10 to 55Hz with 1.5mm amplitude 2hours
Suzhou maswell communication technology co.,ltd	Environmentally Friendly	ROHS Compliant

Maswell Cellular 5G/4G 8X8 MIMO Antenna Screw Mount IP67 UV stabilized L Plate Mount

AN_Master_Cubic-8C-LP

Measured Reflection Coefficient S11

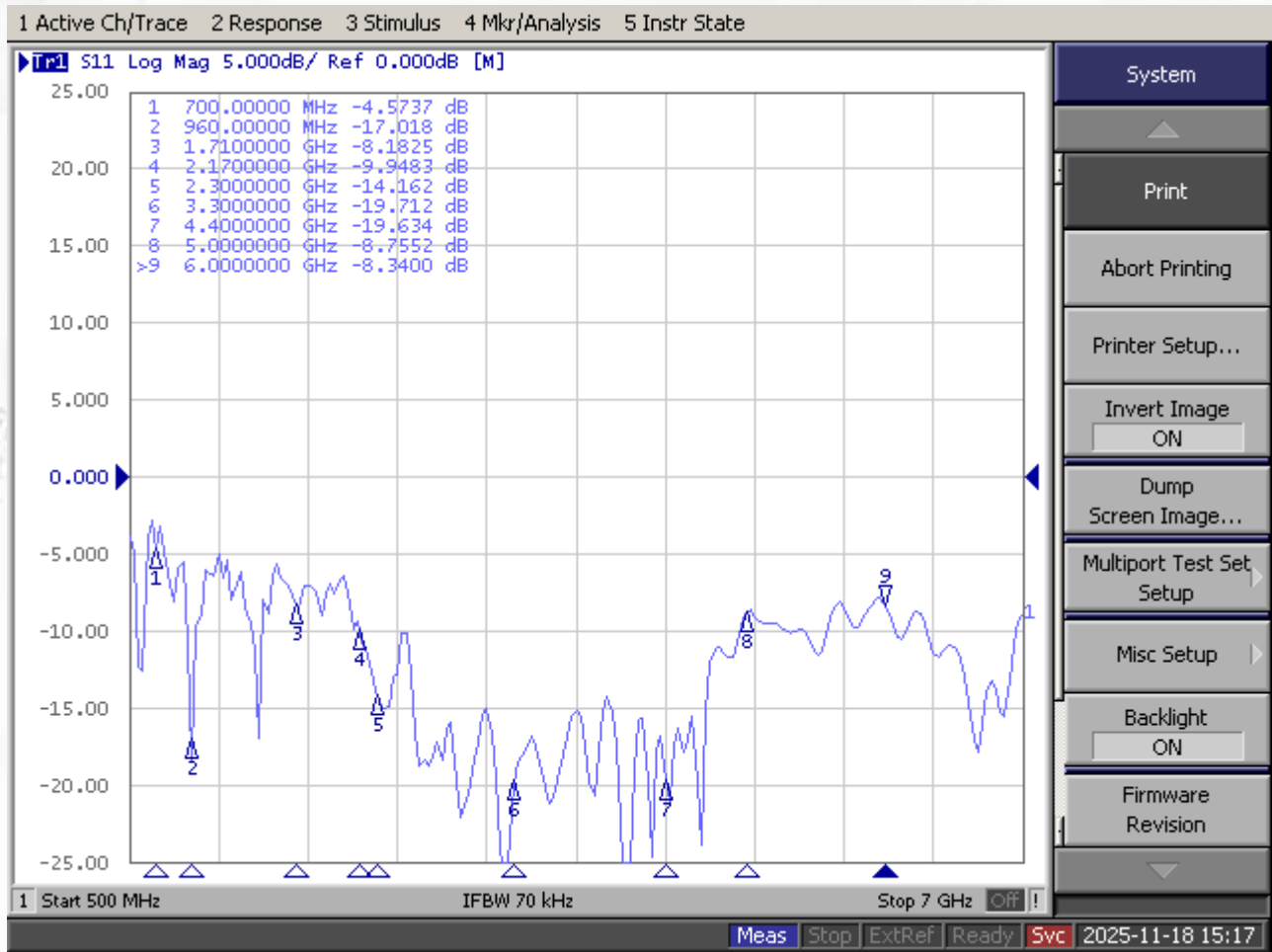

Maswell Cellular 5G/4G 8X8 MIMO Antenna Screw Mount IP67 UV stabilized L Plate Mount

AN_Master_Cubic-8C-LP

Measured Reflection Coefficient S22

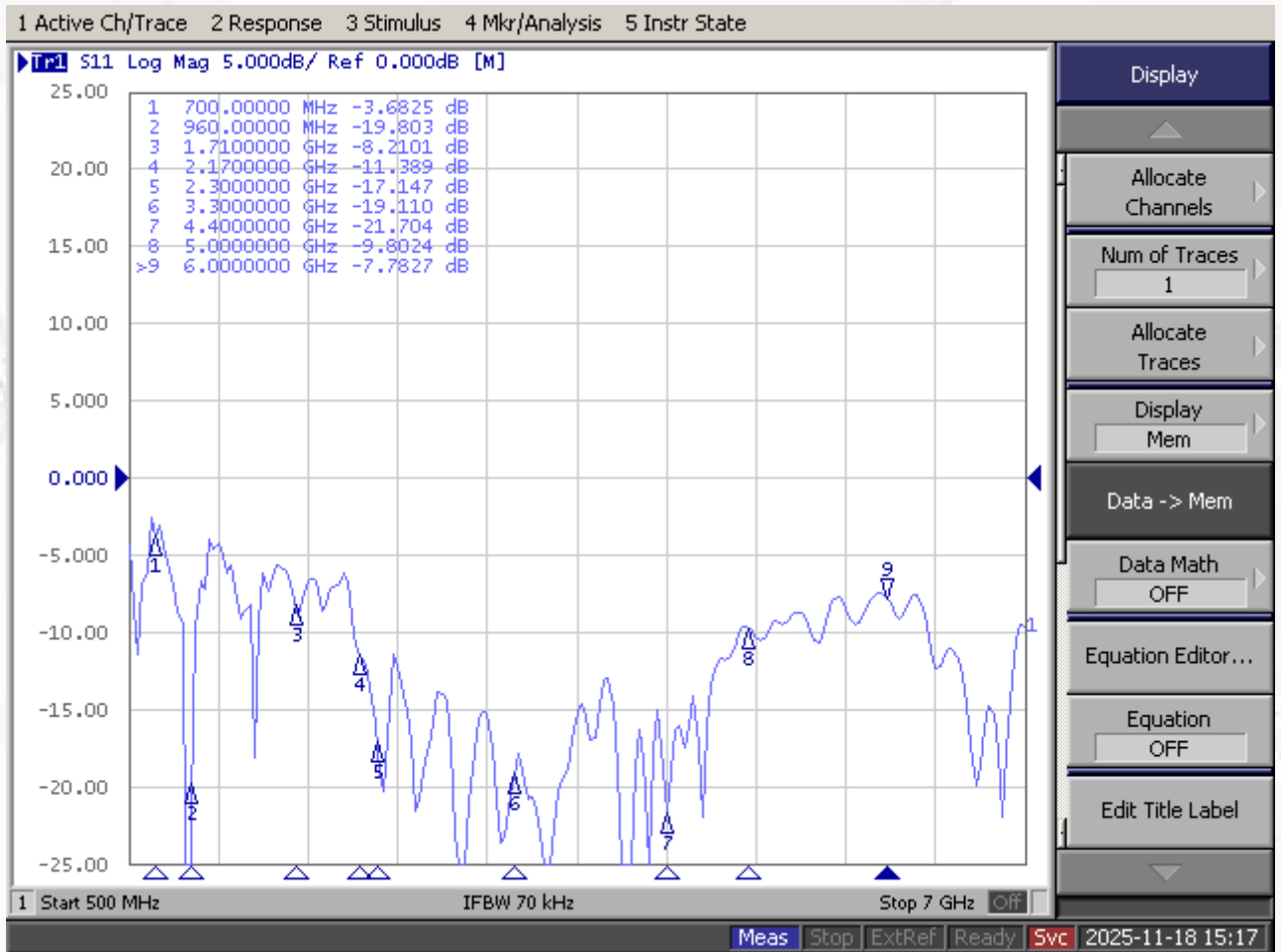

Maswell Cellular 5G/4G 8X8 MIMO Antenna Screw Mount IP67 UV stabilized L Plate Mount

AN_Master_Cubic-8C-LP

Measured Reflection Coefficient S33

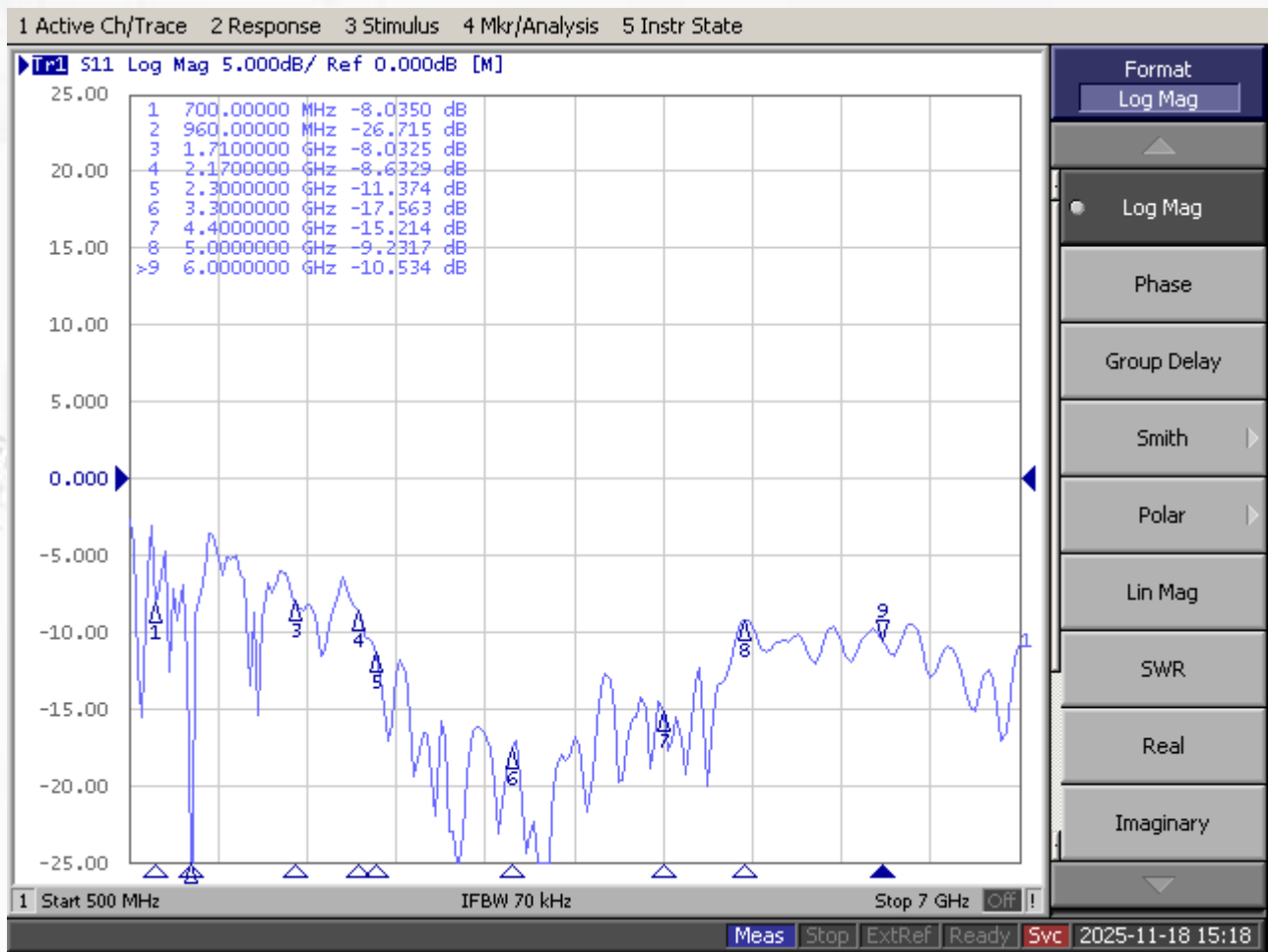

Maswell Cellular 5G/4G 8X8 MIMO Antenna Screw Mount IP67 UV stabilized L Plate Mount

AN_Master_Cubic-8C-LP

Measured Reflection Coefficient S44

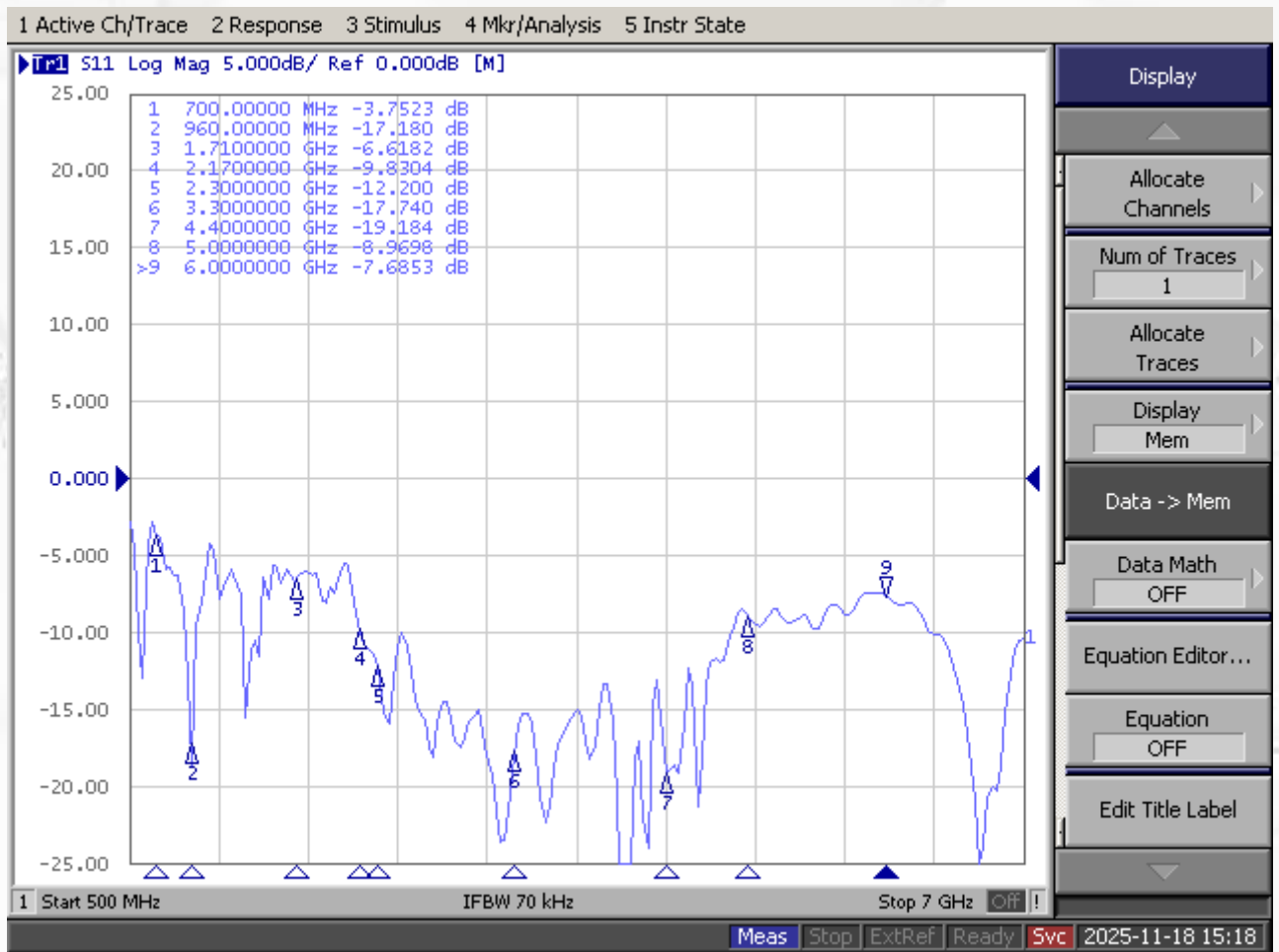

Maswell Cellular 5G/4G 8X8 MIMO Antenna Screw Mount IP67 UV stabilized L Plate Mount

AN_Master_Cubic-8C-LP

Measured Reflection Coefficient S₁₁

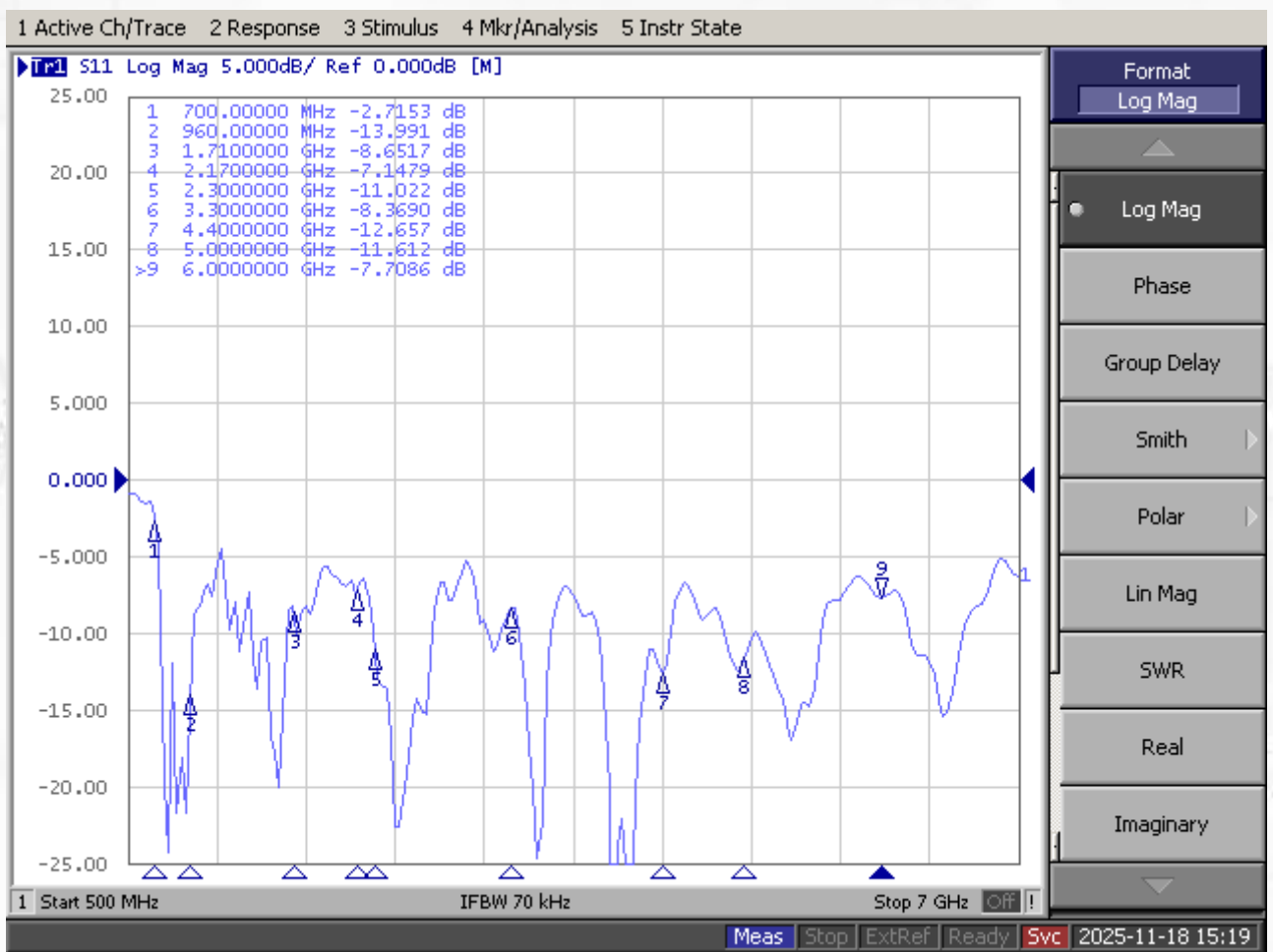

Maswell Cellular 5G/4G 8X8 MIMO Antenna Screw Mount IP67 UV stabilized L Plate Mount

AN_Master_Cubic-8C-LP

Measured Reflection Coefficient S66

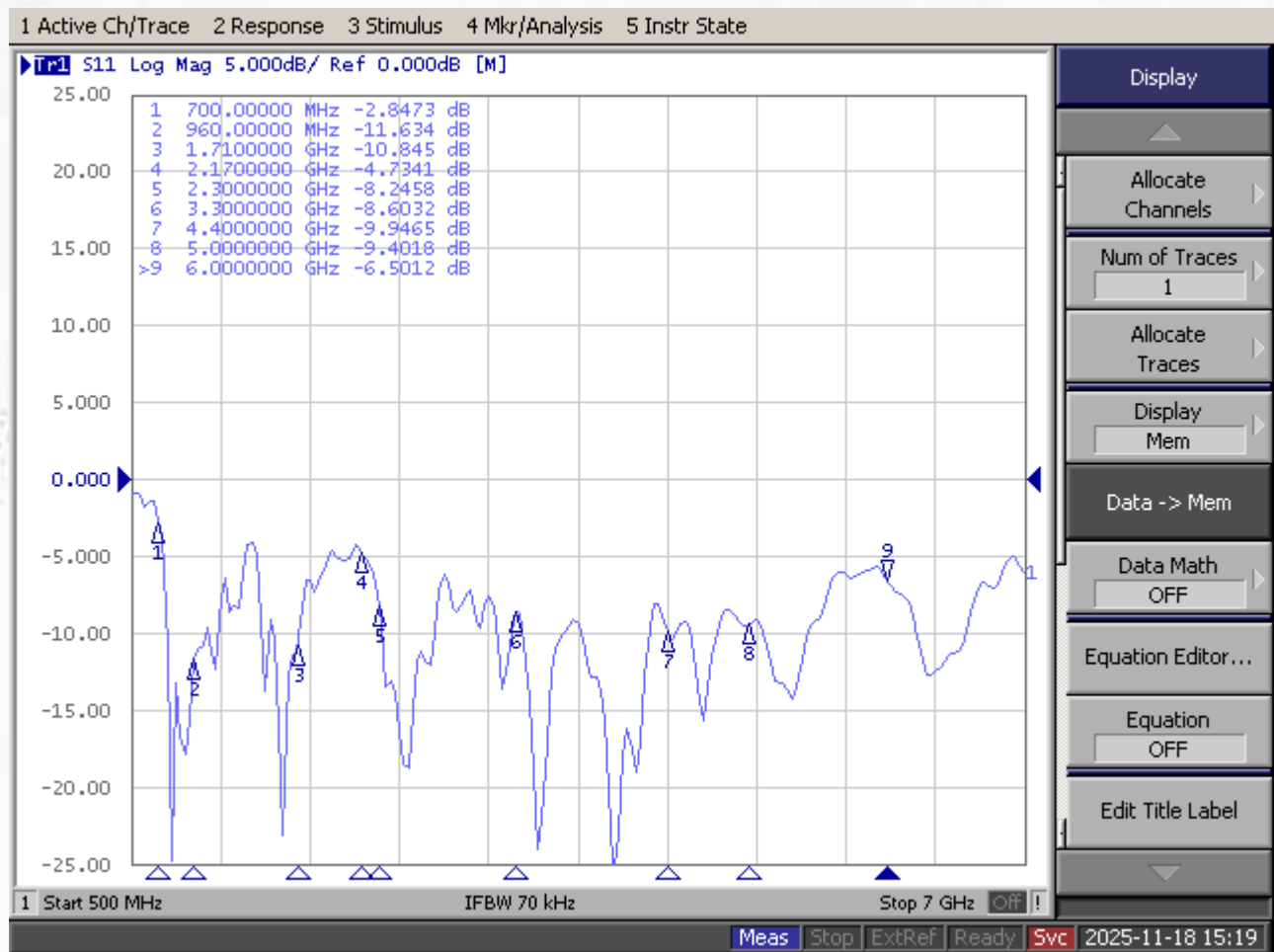

Maswell Cellular 5G/4G 8X8 MIMO Antenna Screw Mount IP67 UV stabilized L Plate Mount

AN_Master_Cubic-8C-LP

Measured Reflection Coefficient S77

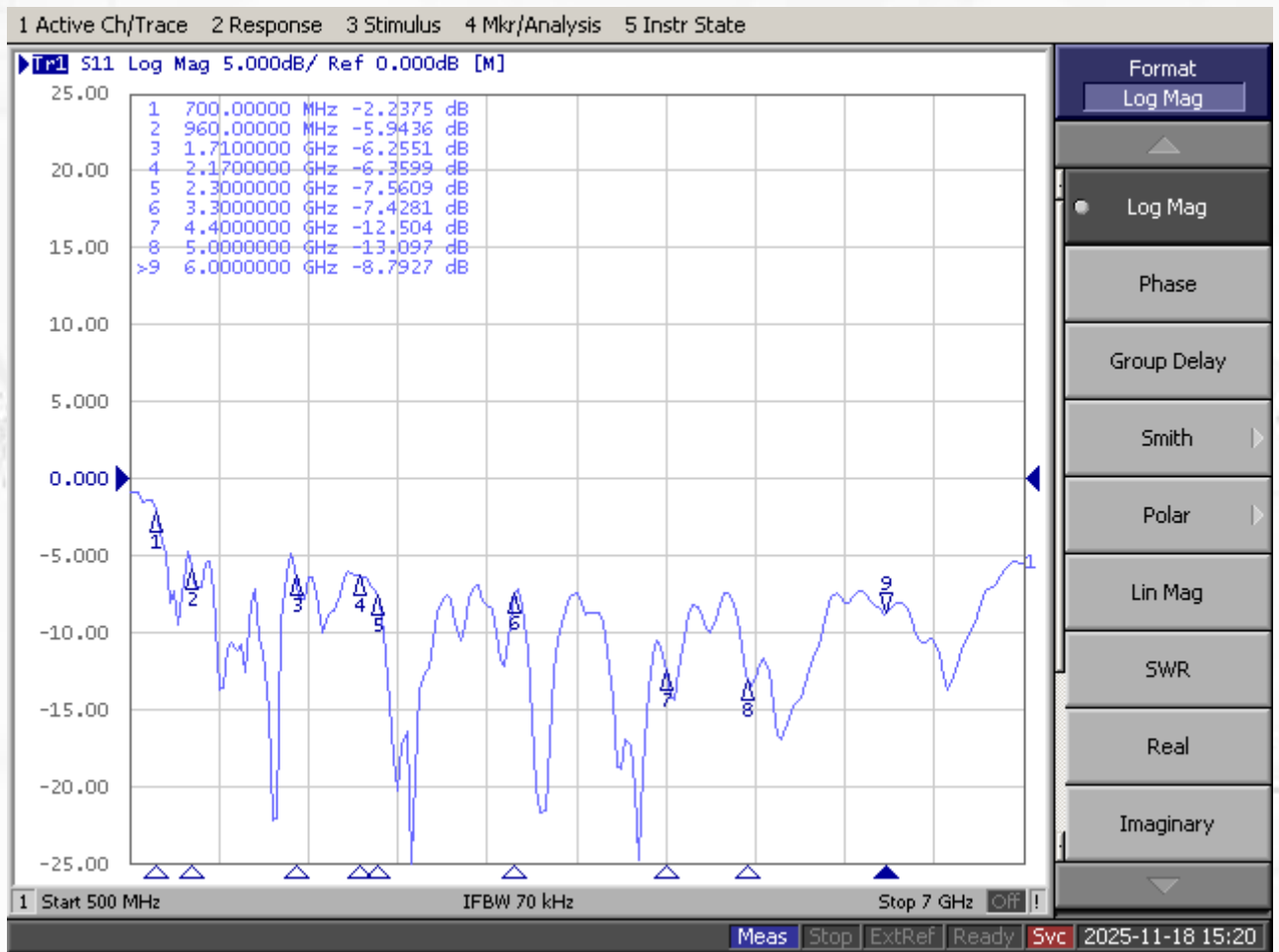

Maswell Cellular 5G/4G 8X8 MIMO Antenna Screw Mount IP67 UV stabilized L Plate Mount

AN_Master_Cubic-8C-LP

Measured Reflection Coefficient S88

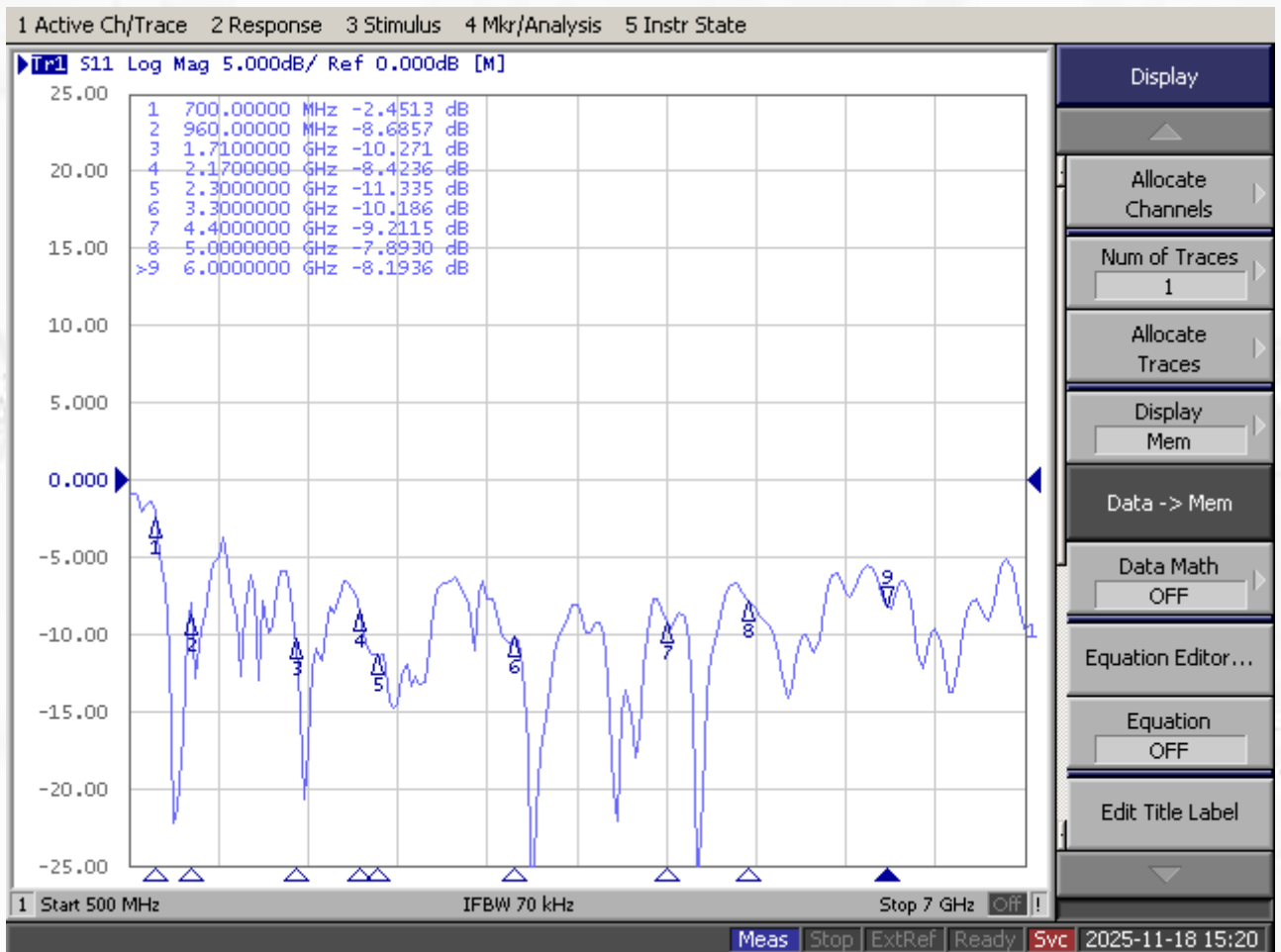

Maswell Cellular 5G/4G 8X8 MIMO Antenna Screw Mount IP67 UV stabilized L Plate Mount

AN_Master_Cubic-8C-LP

Isolation

Isolation between Antenna 1/Cable 1 to Other Antennas/Cables

S21

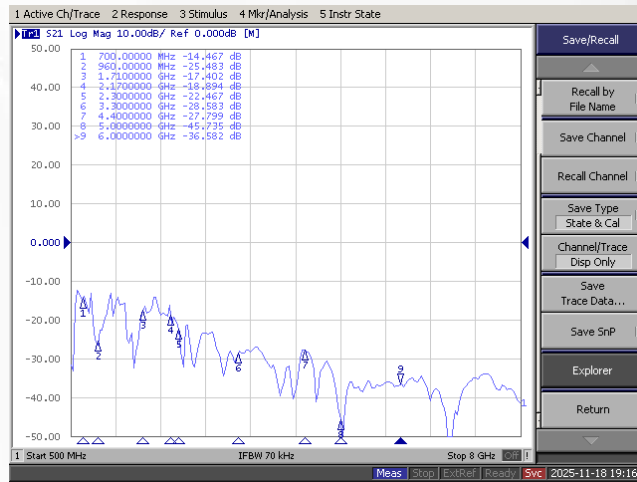

S31

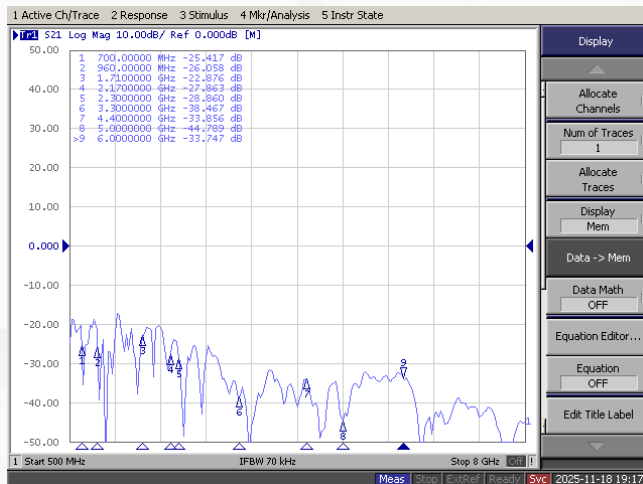

Maswell Cellular 5G/4G 8X8 MIMO Antenna Screw Mount IP67 UV stabilized L Plate Mount

AN_Master_Cubic-8C-LP

Isolation

Isolation between Antenna 1/Cable 1 to Other Antennas/Cables

S41

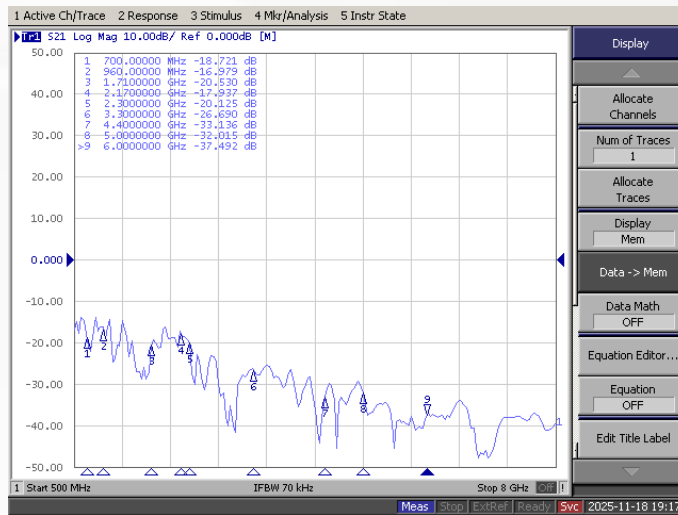

S51

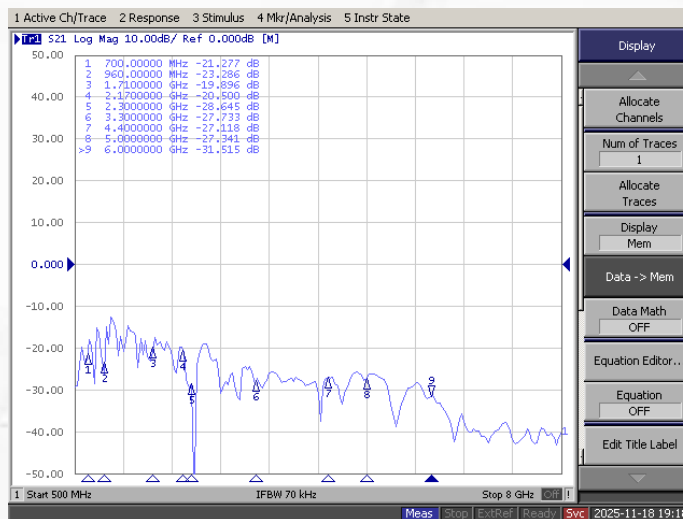

Maswell Cellular 5G/4G 8X8 MIMO Antenna Screw Mount IP67 UV stabilized L Plate Mount

AN_Master_Cubic-8C-LP

Isolation

Isolation between Antenna 1/Cable 1 to Other Antennas/Cables

S61

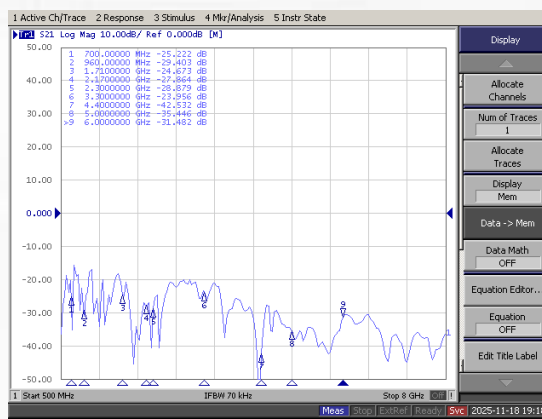

S71

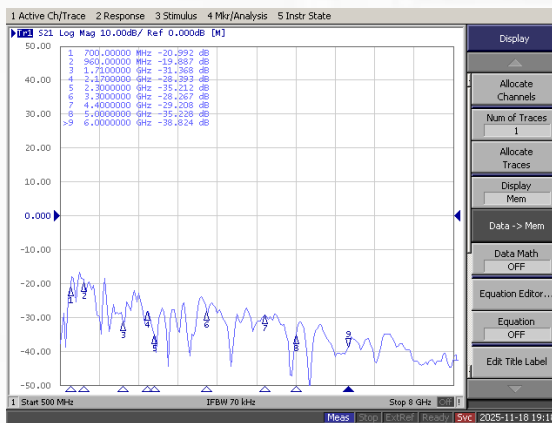

S81

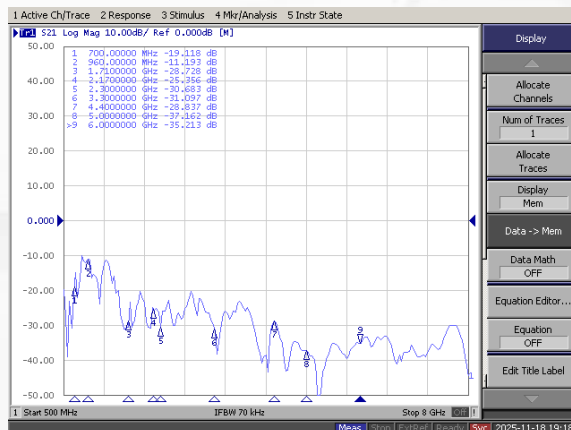

Maswell Cellular 5G/4G 8X8 MIMO Antenna Screw Mount IP67 UV stabilized L Plate Mount

AN_Master_Cubic-8C-LP

Isolation

Isolation between Antenna 2/Cable 2 to Other Antennas/Cables

S12

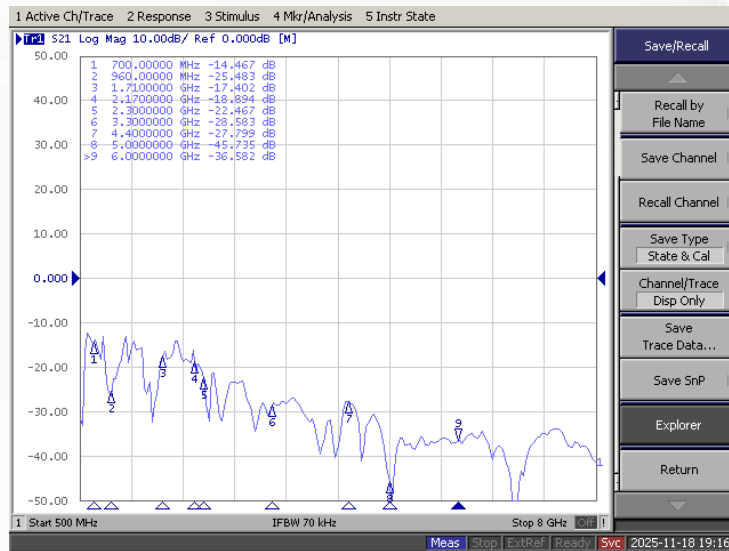

S32



Maswell Cellular 5G/4G 8X8 MIMO Antenna Screw Mount IP67 UV stabilized L Plate Mount

AN_Master_Cubic-8C-LP

Isolation

Isolation between Antenna 2/Cable 2 to Other Antennas/Cables

S42

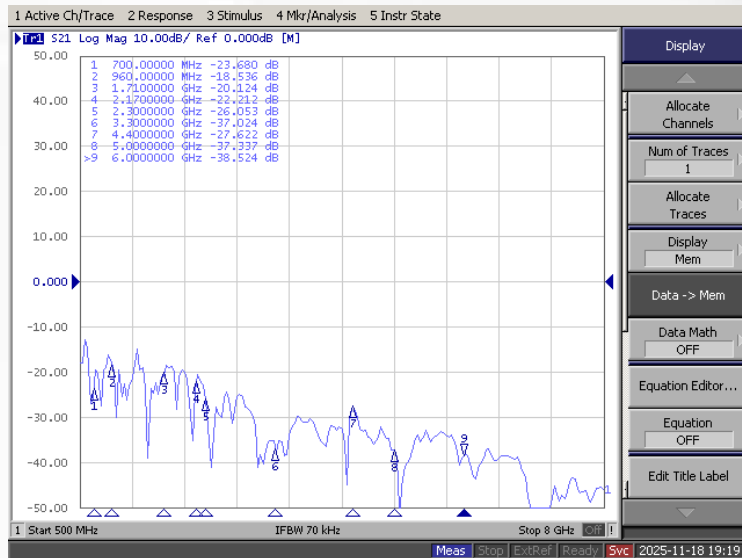

S52

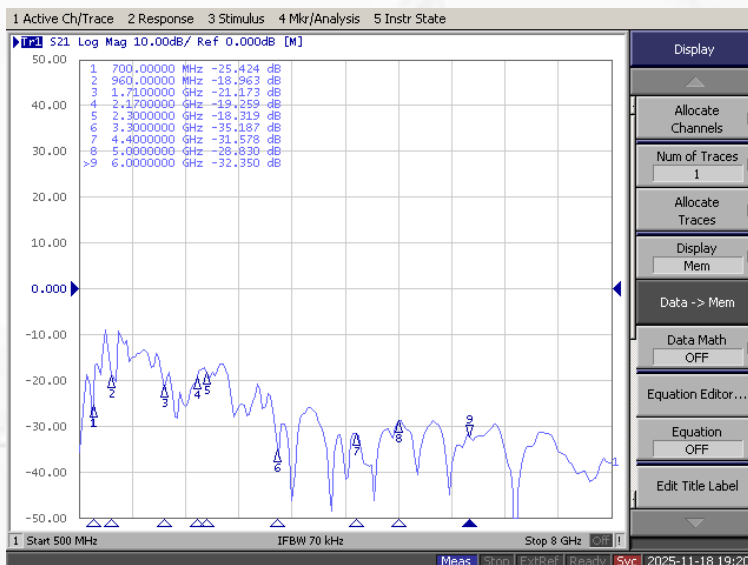

Maswell Cellular 5G/4G 8X8 MIMO Antenna Screw Mount IP67 UV stabilized L Plate Mount

AN_Master_Cubic-8C-LP

Isolation

Isolation between Antenna 2/Cable 2 to Other Antennas/Cables

S62



S72

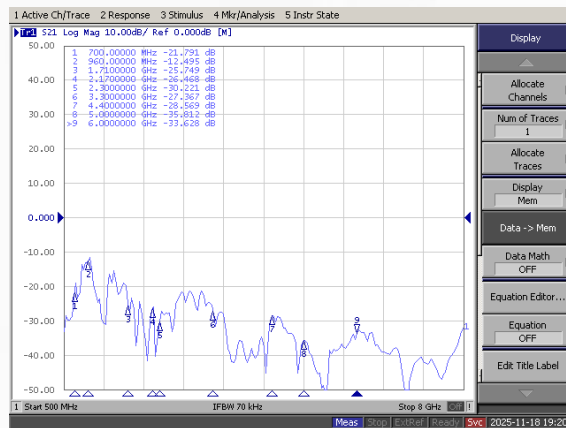

S82

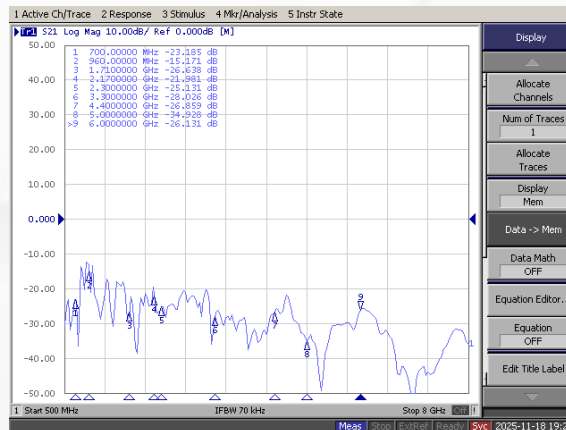

Maswell Cellular 5G/4G 8X8 MIMO Antenna Screw Mount IP67 UV stabilized L Plate Mount

AN_Master_Cubic-8C-LP

Isolation

Isolation between Antenna 3/Cable 3 to Other Antennas/Cables

S13

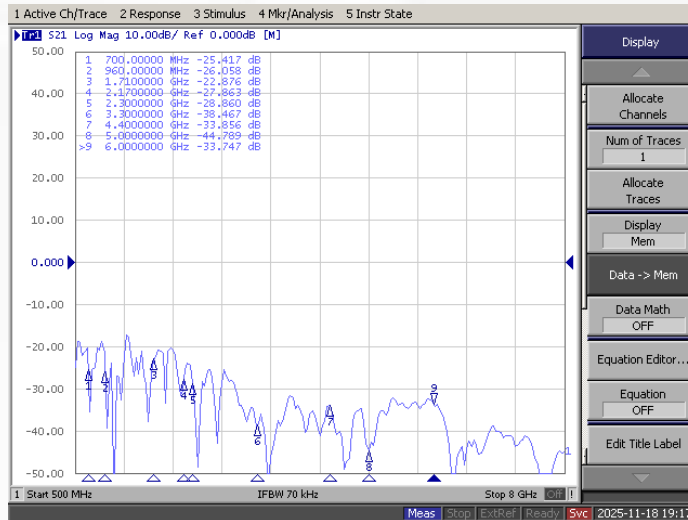

S23



Maswell Cellular 5G/4G 8X8 MIMO Antenna Screw Mount IP67 UV stabilized L Plate Mount

AN_Master_Cubic-8C-LP

Isolation

Isolation between Antenna 3/Cable 3 to Other Antennas/Cables

S43

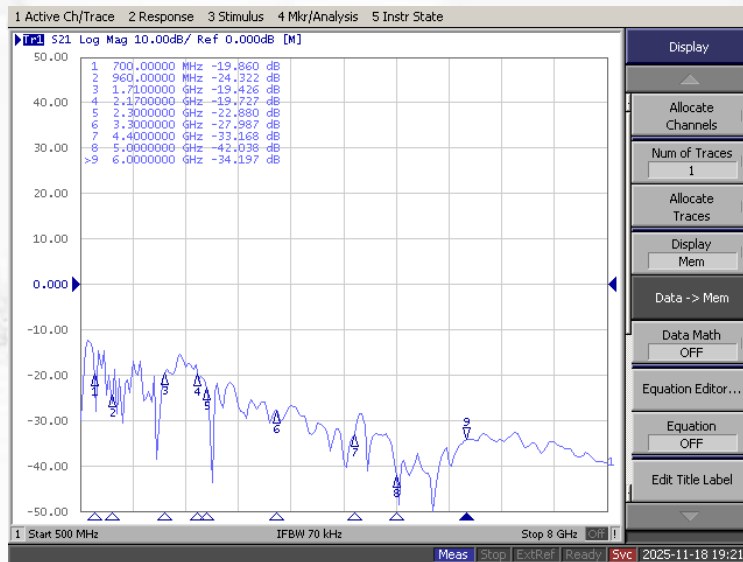

S53

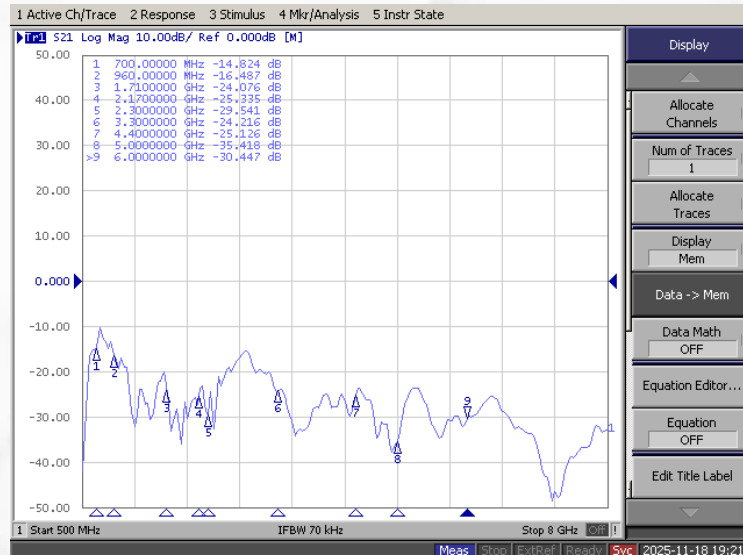

Maswell Cellular 5G/4G 8X8 MIMO Antenna Screw Mount IP67 UV stabilized L Plate Mount

AN_Master_Cubic-8C-LP

Isolation

Isolation between Antenna 3/Cable 3 to Other Antennas/Cables

S63

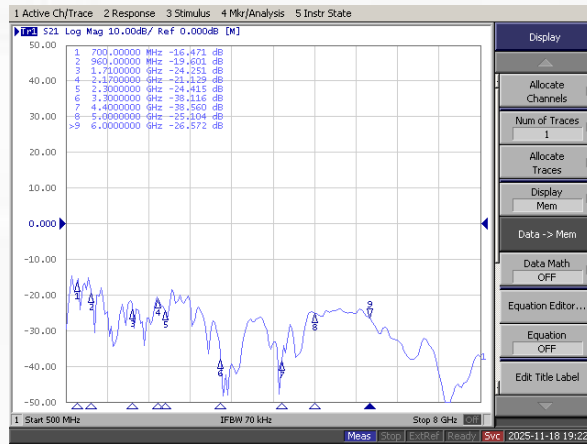

S73

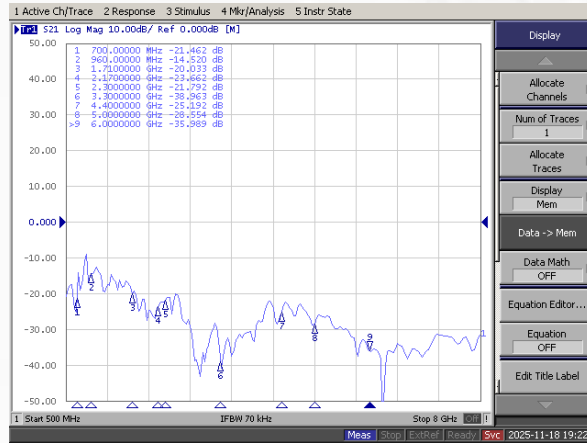

S83

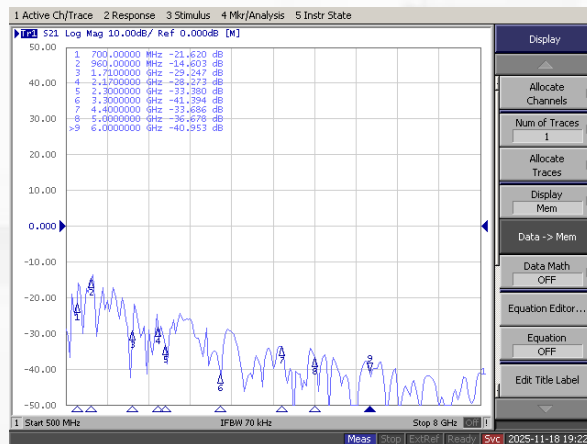

Maswell Cellular 5G/4G 8X8 MIMO Antenna Screw Mount IP67 UV stabilized L Plate Mount

AN_Master_Cubic-8C-LP

Isolation

Isolation between Antenna 4/Cable 4 to Other Antennas/Cables

S14

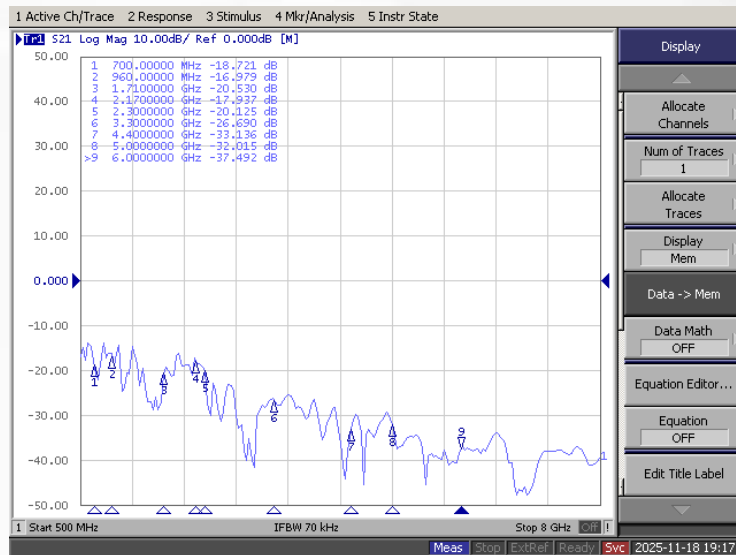

S24

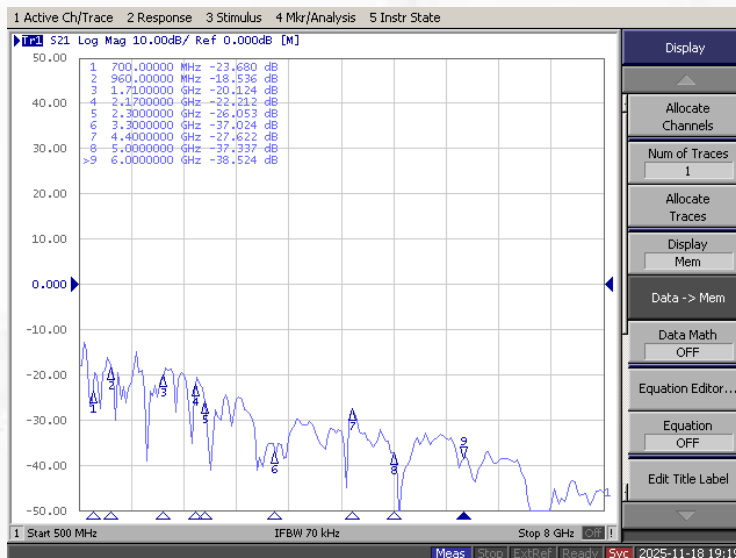

Maswell Cellular 5G/4G 8X8 MIMO Antenna Screw Mount IP67 UV stabilized L Plate Mount

AN_Master_Cubic-8C-LP

Isolation

Isolation between Antenna 4/Cable 4 to Other Antennas/Cables

S34

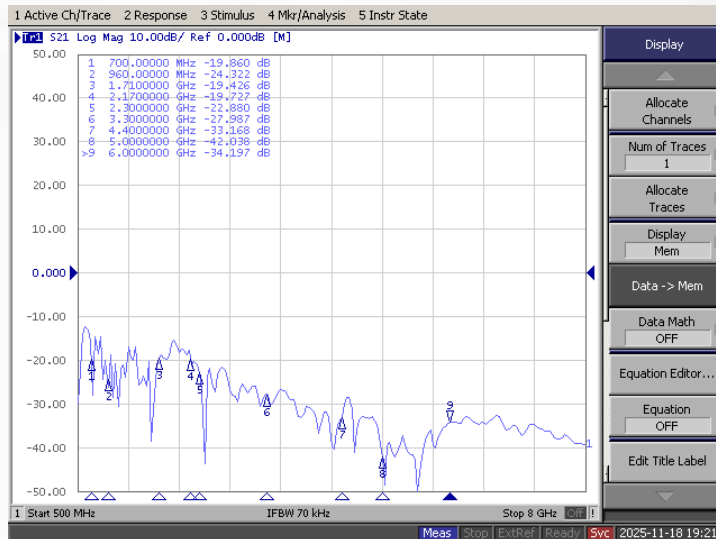

S54

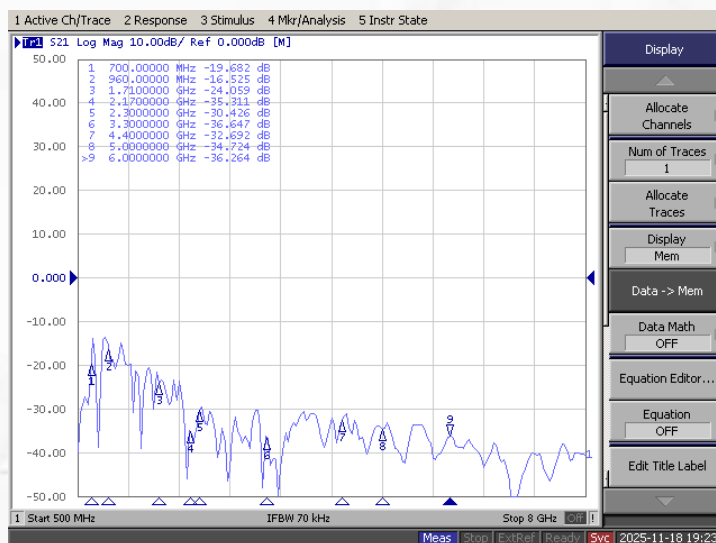

Maswell Cellular 5G/4G 8X8 MIMO Antenna Screw Mount IP67 UV stabilized L Plate Mount

AN_Master_Cubic-8C-LP

Isolation

Isolation between Antenna 4/Cable 4 to Other Antennas/Cables

S64

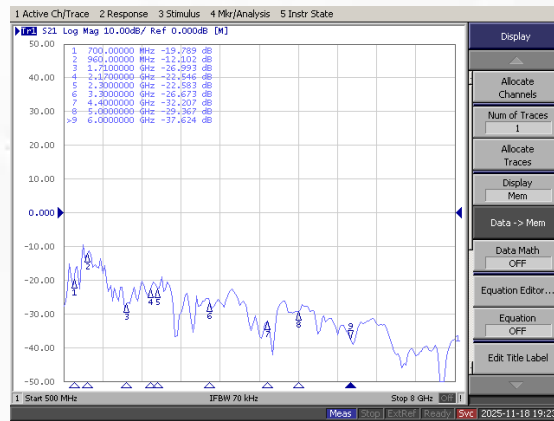

S74

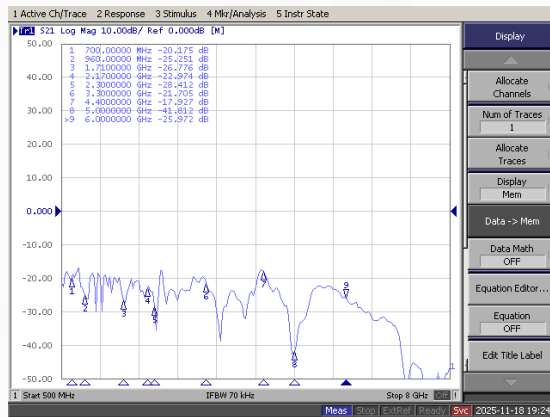

S84

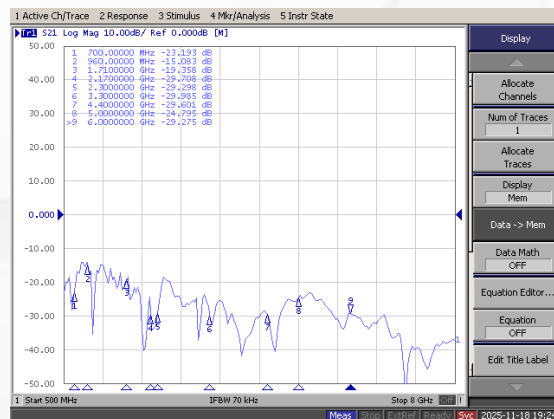

Maswell Cellular 5G/4G 8X8 MIMO Antenna Screw Mount IP67 UV stabilized L Plate Mount

AN_Master_Cubic-8C-LP

Isolation

Isolation between Antenna 5/Cable 5 to Other Antennas/Cables

S15

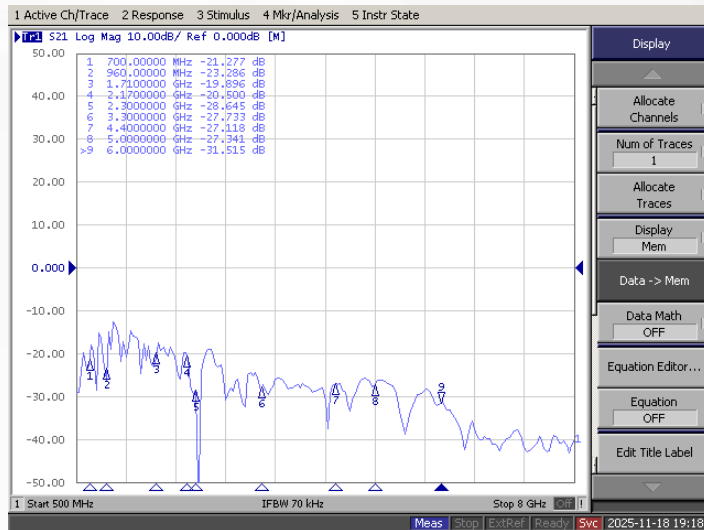

S25

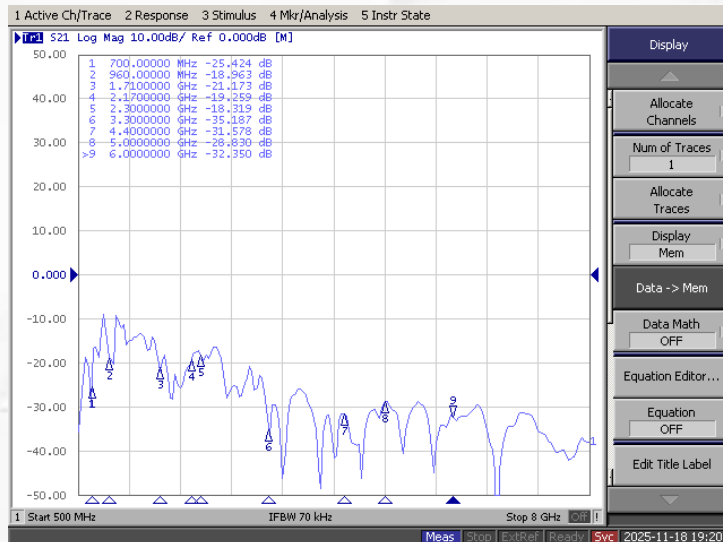

Maswell Cellular 5G/4G 8X8 MIMO Antenna Screw Mount IP67 UV stabilized L Plate Mount

AN_Master_Cubic-8C-LP

Isolation

Isolation between Antenna 5/Cable 5 to Other Antennas/Cables

S35

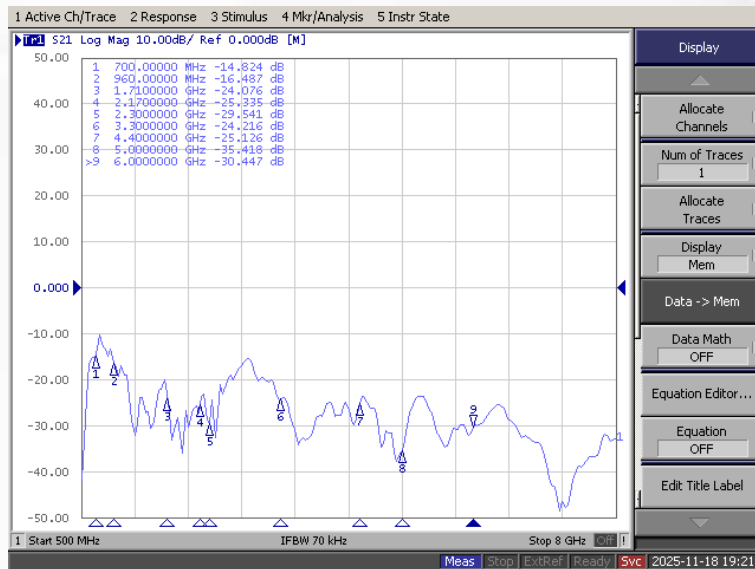

S45

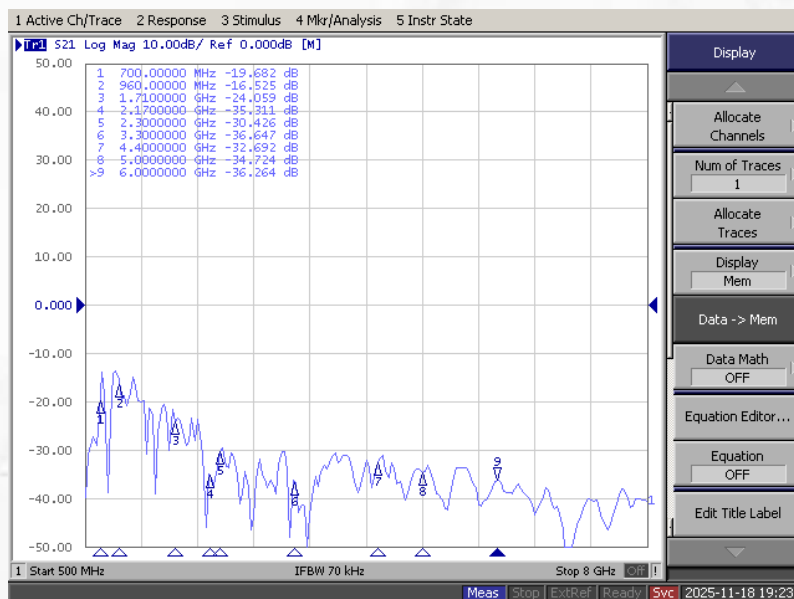

Maswell Cellular 5G/4G 8X8 MIMO Antenna Screw Mount IP67 UV stabilized L Plate Mount

AN_Master_Cubic-8C-LP

Isolation

Isolation between Antenna 5/Cable 5 to Other Antennas/Cables

S65

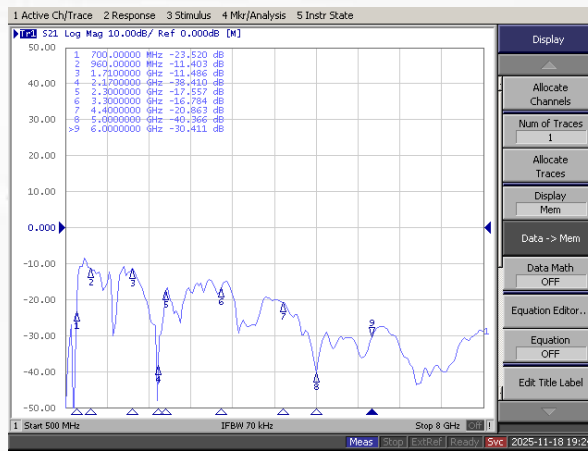

S75

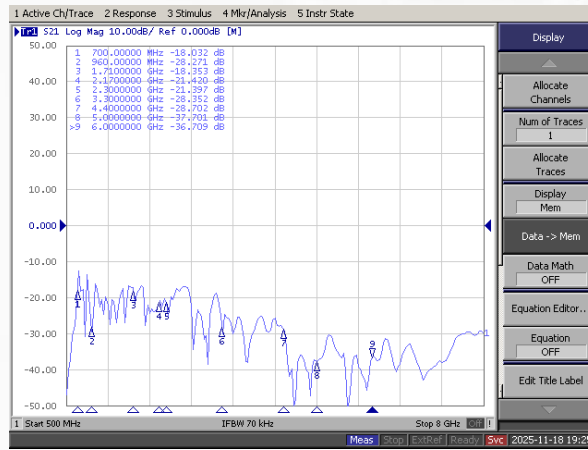

S85

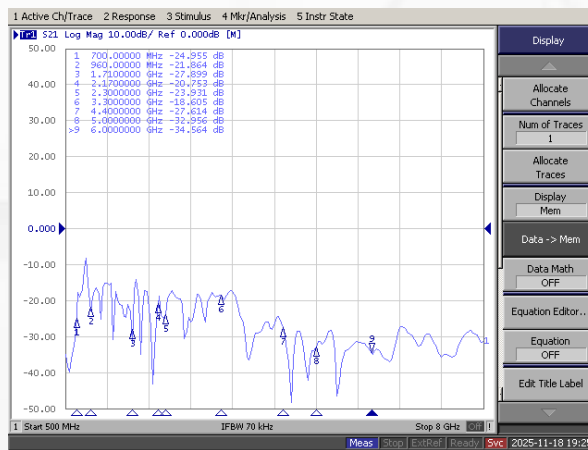

Maswell Cellular 5G/4G 8X8 MIMO Antenna Screw Mount IP67 UV stabilized L Plate Mount

AN_Master_Cubic-8C-LP

Isolation

Isolation between Antenna 6/Cable 6 to Other Antennas/Cables

S16

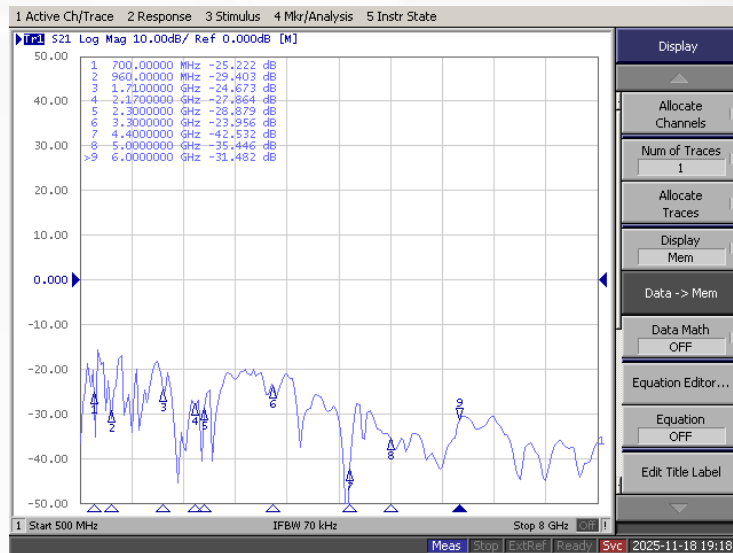

S26

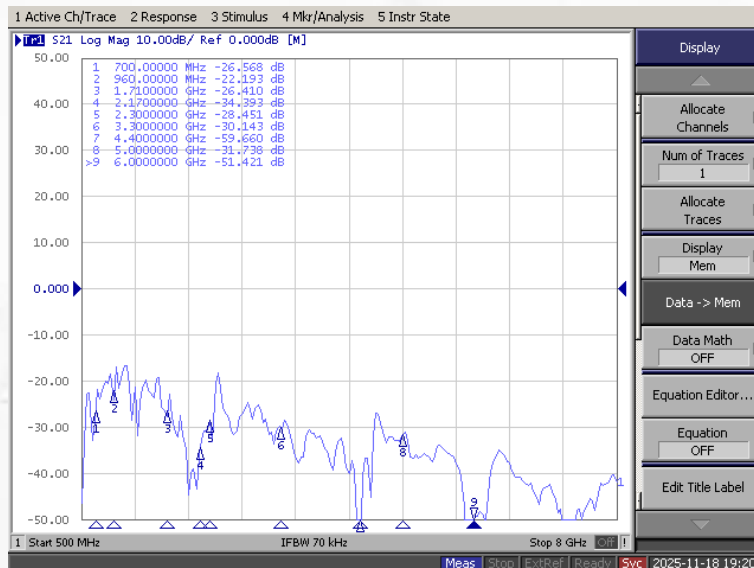

Maswell Cellular 5G/4G 8X8 MIMO Antenna Screw Mount IP67 UV stabilized L Plate Mount

AN_Master_Cubic-8C-LP

Isolation

Isolation between Antenna 6/Cable 6 to Other Antennas/Cables

S36

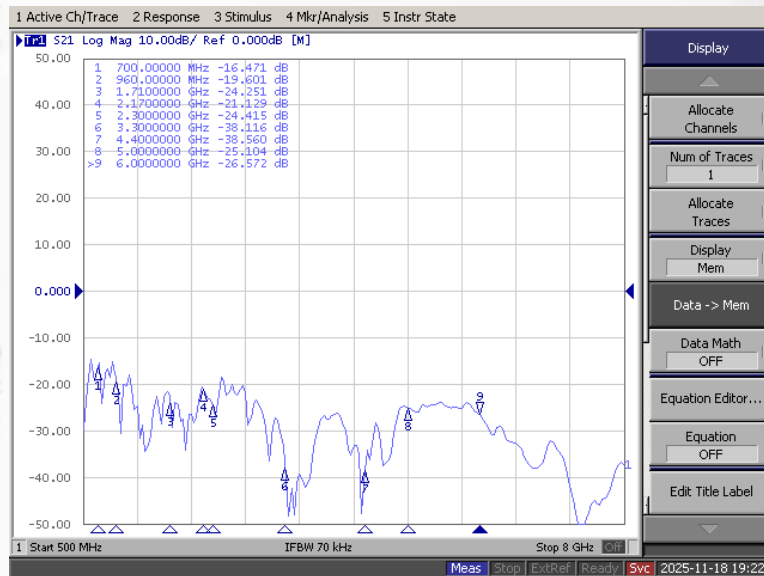

S46

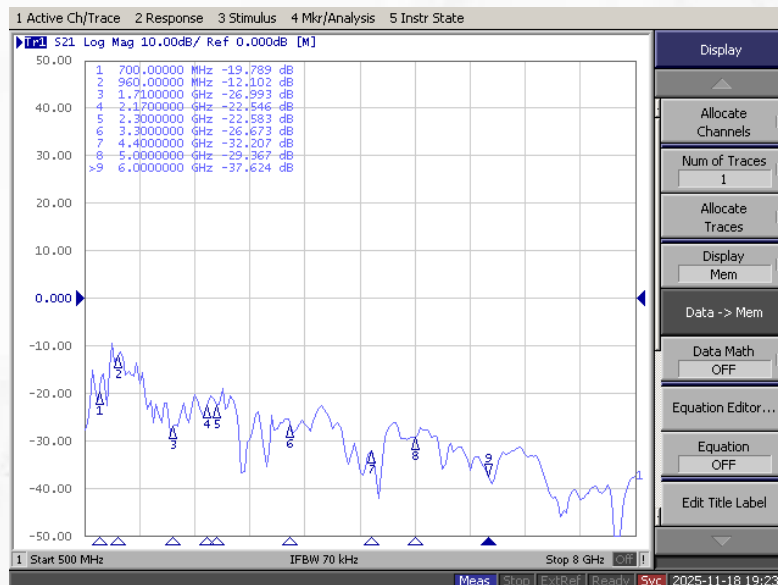

Maswell Cellular 5G/4G 8X8 MIMO Antenna Screw Mount IP67 UV stabilized L Plate Mount

AN_Master_Cubic-8C-LP

Isolation

Isolation between Antenna 6/Cable 6 to Other Antennas/Cables

S56

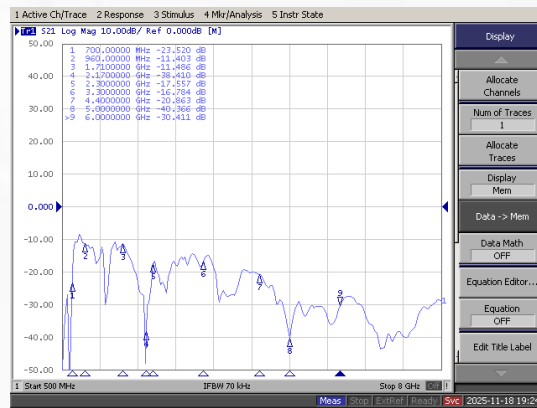

S76

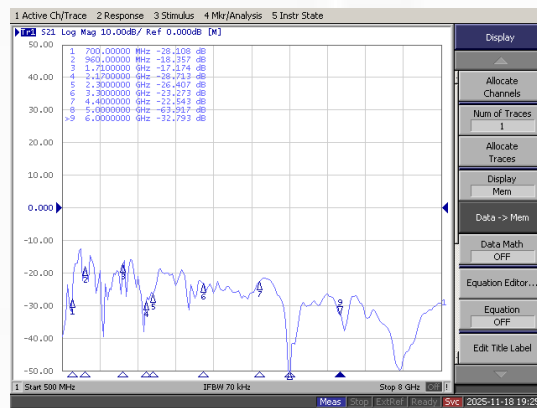

S86

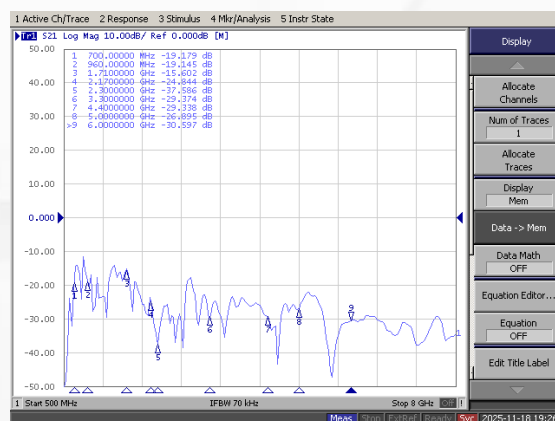

Maswell Cellular 5G/4G 8X8 MIMO Antenna Screw Mount IP67 UV stabilized L Plate Mount

AN_Master_Cubic-8C-LP

Isolation

Isolation between Antenna 7/Cable 7 to Other Antennas/Cables

S17

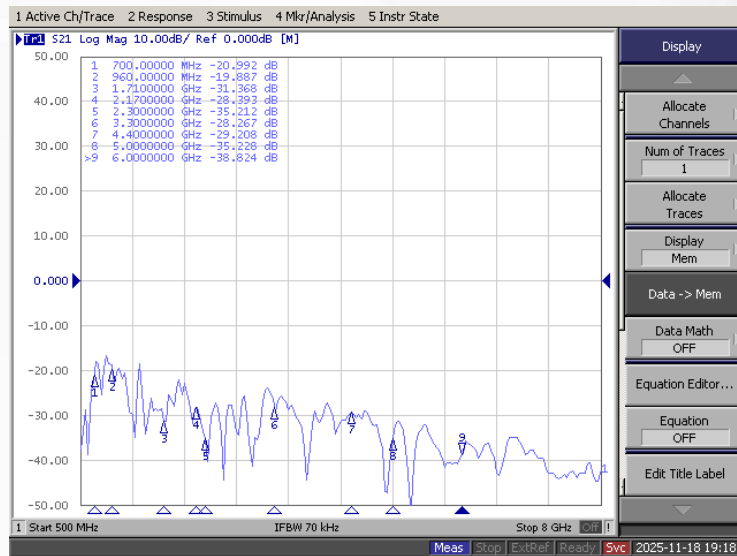

S27

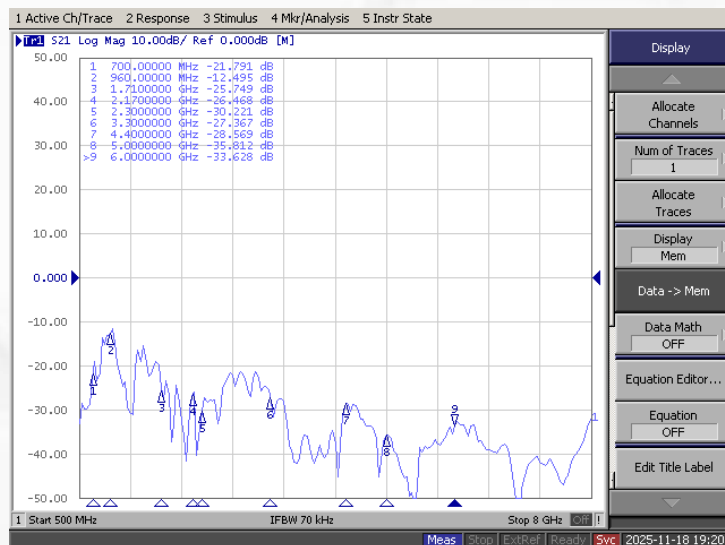

Maswell Cellular 5G/4G 8X8 MIMO Antenna Screw Mount IP67 UV stabilized L Plate Mount

AN_Master_Cubic-8C-LP

Isolation

Isolation between Antenna 7/Cable 7 to Other Antennas/Cables

S37

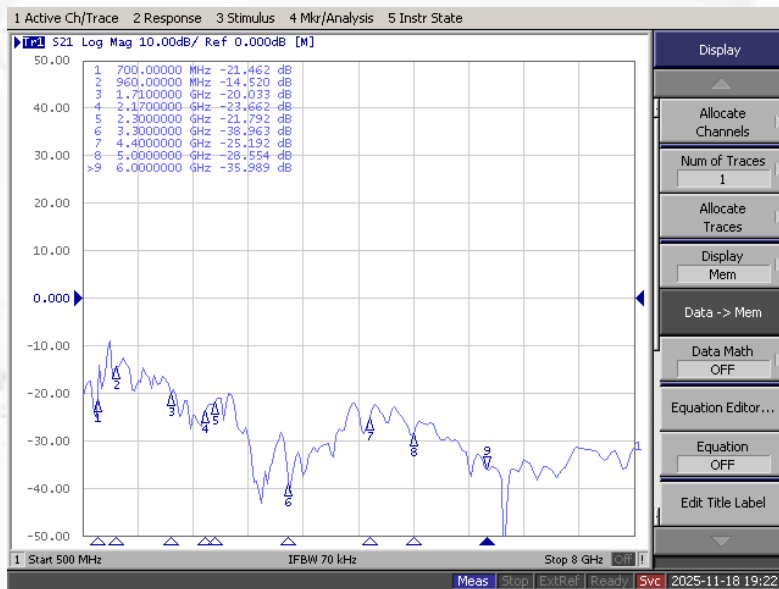

S47

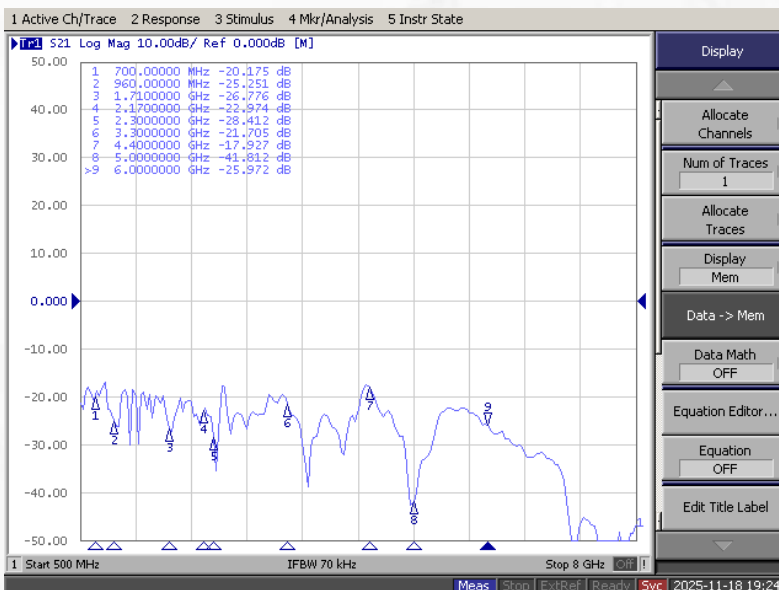

Maswell Cellular 5G/4G 8X8 MIMO Antenna Screw Mount IP67 UV stabilized L Plate Mount

AN_Master_Cubic-8C-LP

Isolation

Isolation between Antenna 7/Cable 7 to Other Antennas/Cables

S57

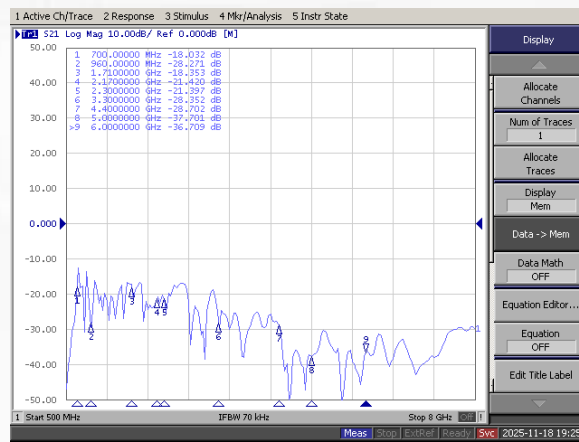

S67

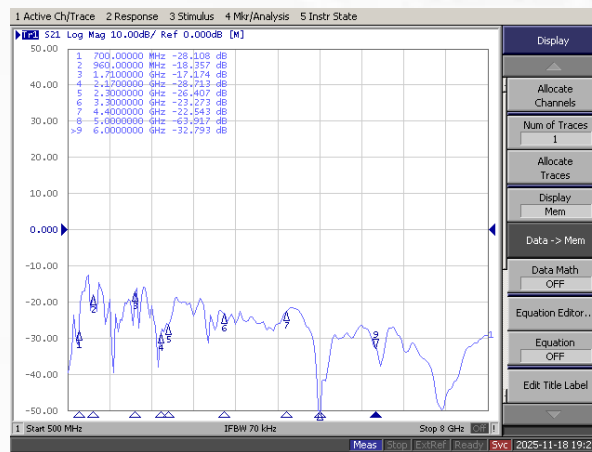

S87

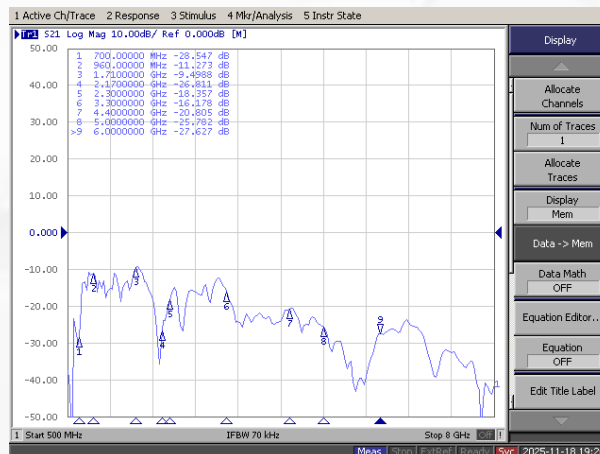

Maswell Cellular 5G/4G 8X8 MIMO Antenna Screw Mount IP67 UV stabilized L Plate Mount

AN_Master_Cubic-8C-LP

Isolation

Isolation between Antenna 8/Cable 8 to Other Antennas/Cables

S18

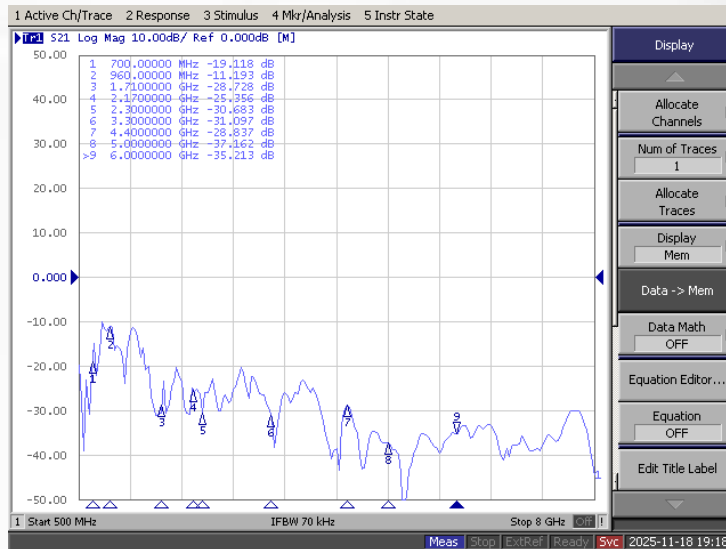

S28

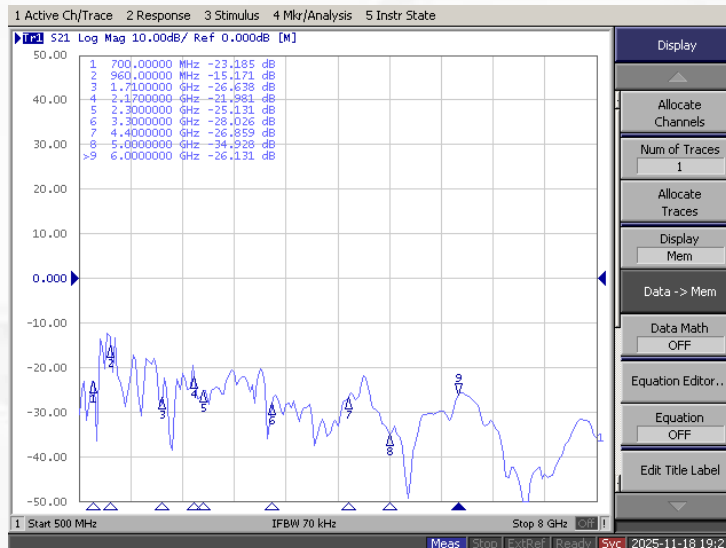

Maswell Cellular 5G/4G 8X8 MIMO Antenna Screw Mount IP67 UV stabilized L Plate Mount

AN_Master_Cubic-8C-LP

Isolation

Isolation between Antenna 8/Cable 8 to Other Antennas/Cables

S38

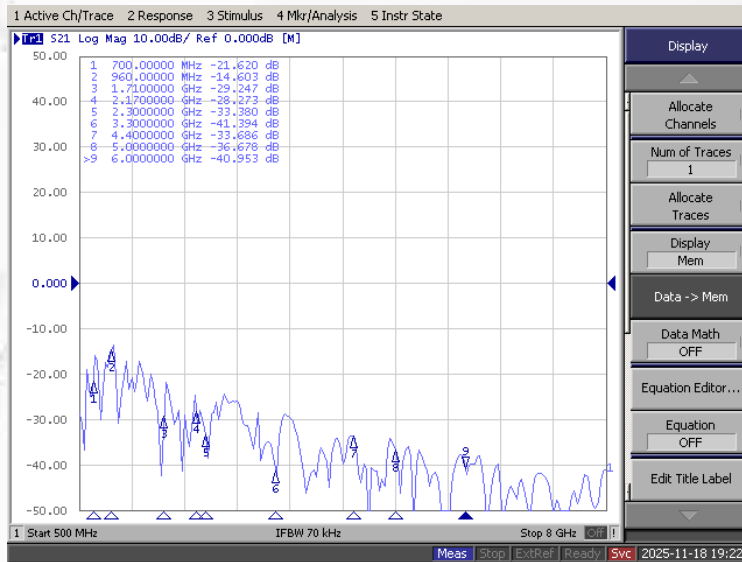

S48

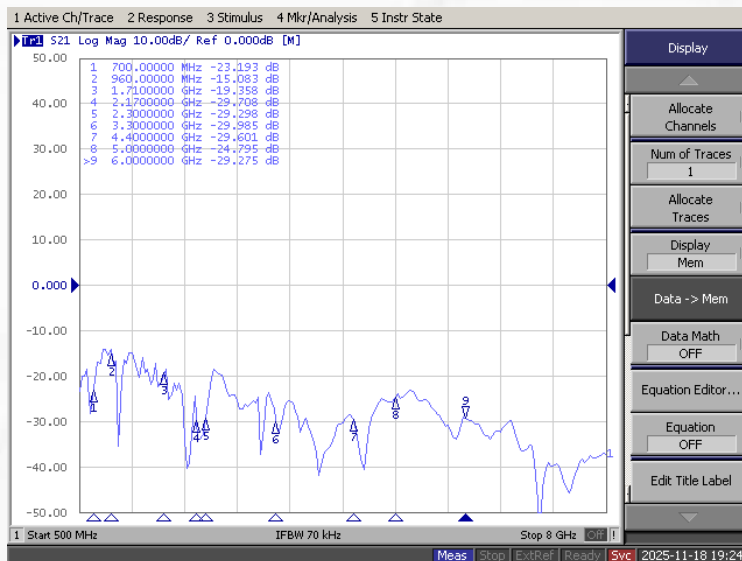

Maswell Cellular 5G/4G 8X8 MIMO Antenna Screw Mount IP67 UV stabilized L Plate Mount

AN_Master_Cubic-8C-LP

Isolation

Isolation between Antenna 8/Cable 8 to Other Antennas/Cables

S58

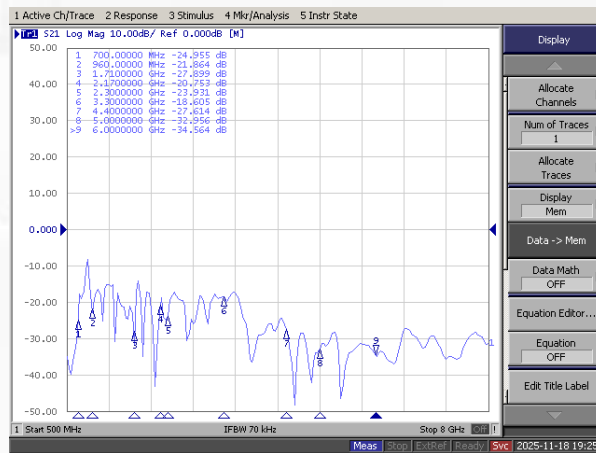

S68

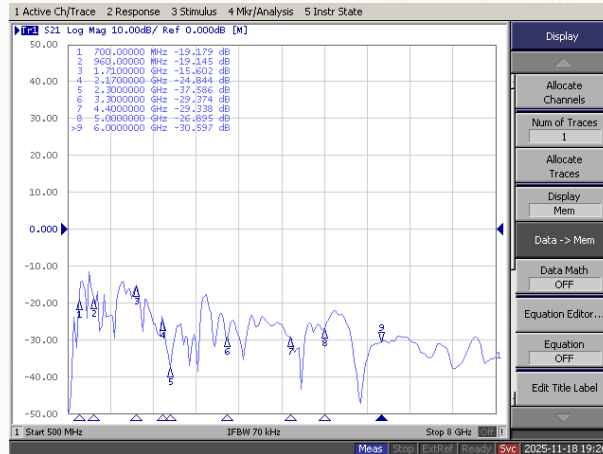

S78

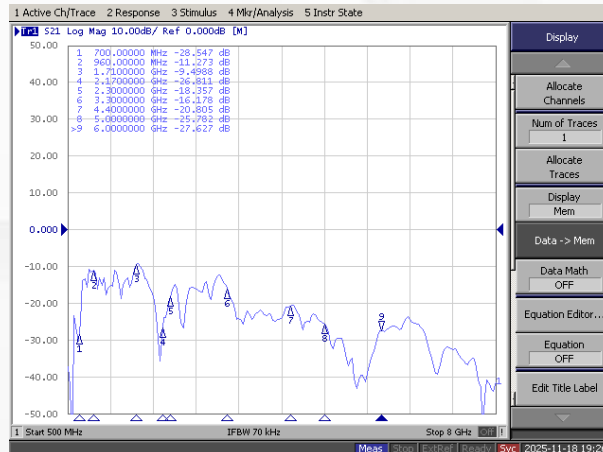

Maswell Cellular 5G/4G 8X8 MIMO Antenna Screw Mount IP67 UV stabilized L Plate Mount

AN_Master_Cubic-8C-LP

Measurement Gain Performance Antenna 1/Cable 1

400.00MHz - 8000.00MHz Gain

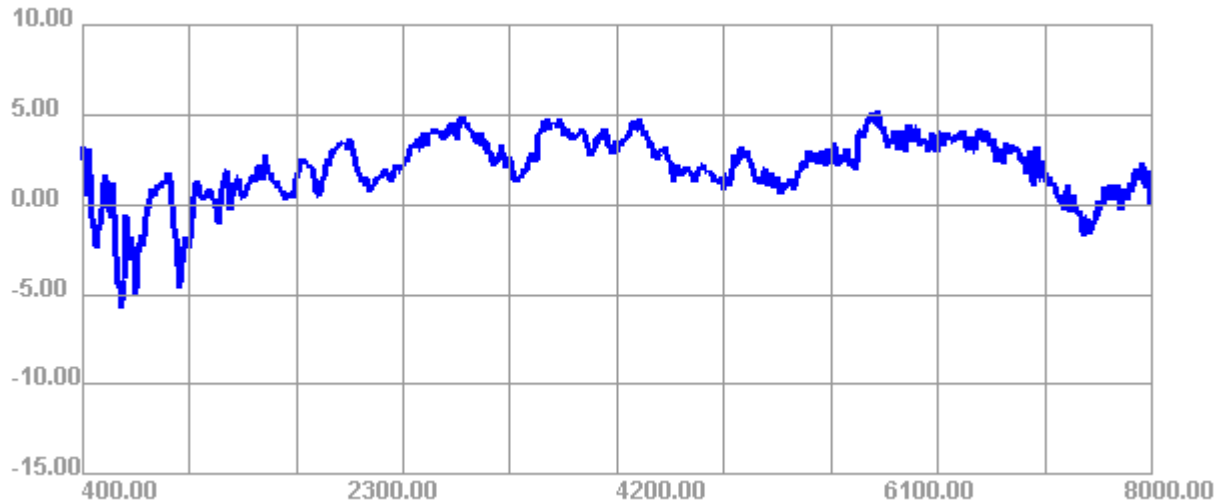

400.00MHz - 8000.00MHz Efficiency



Maswell Cellular 5G/4G 8X8 MIMO Antenna Screw Mount IP67 UV stabilized L Plate Mount

AN_Master_Cubic-8C-LP

Measurement Gain Performance Antenna 2/Cable 2

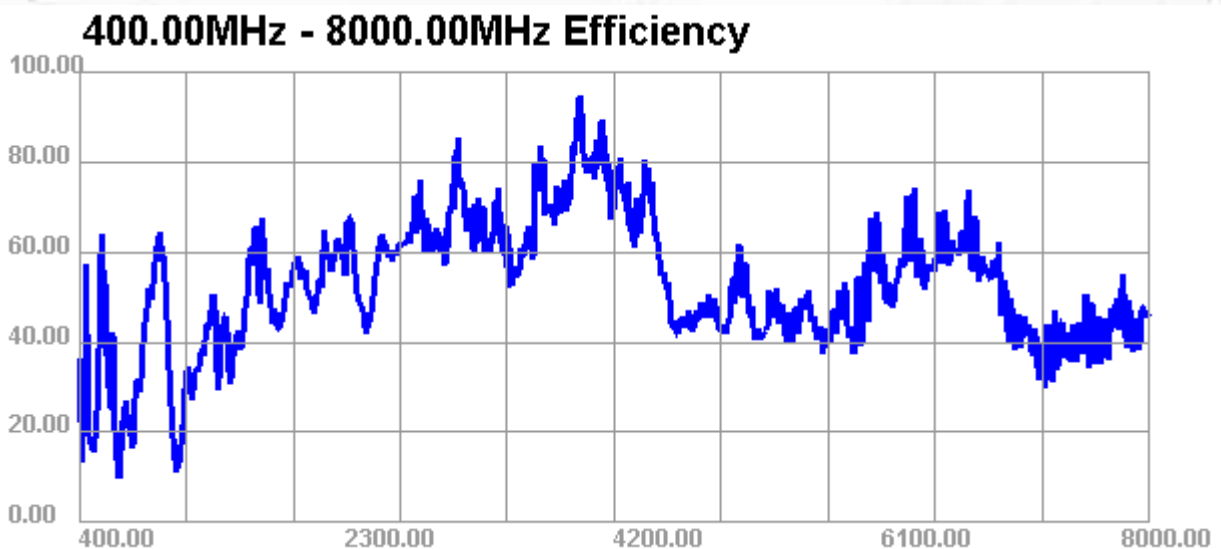
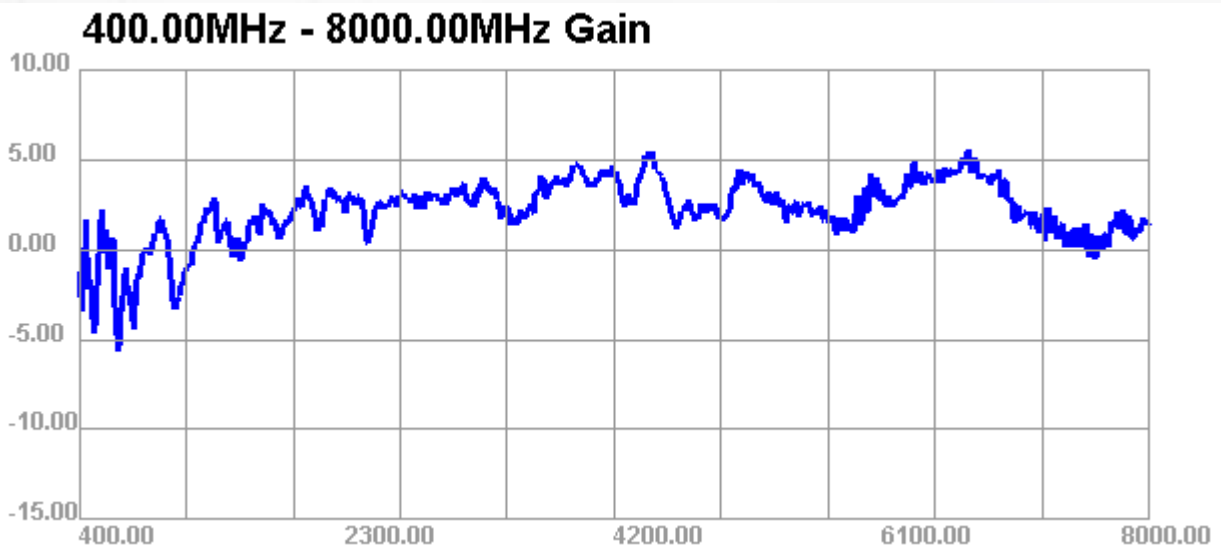

Maswell Cellular 5G/4G 8X8 MIMO Antenna Screw Mount IP67 UV stabilized L Plate Mount

AN_Master_Cubic-8C-LP

Measurement Gain Performance Antenna 3/Cable 3

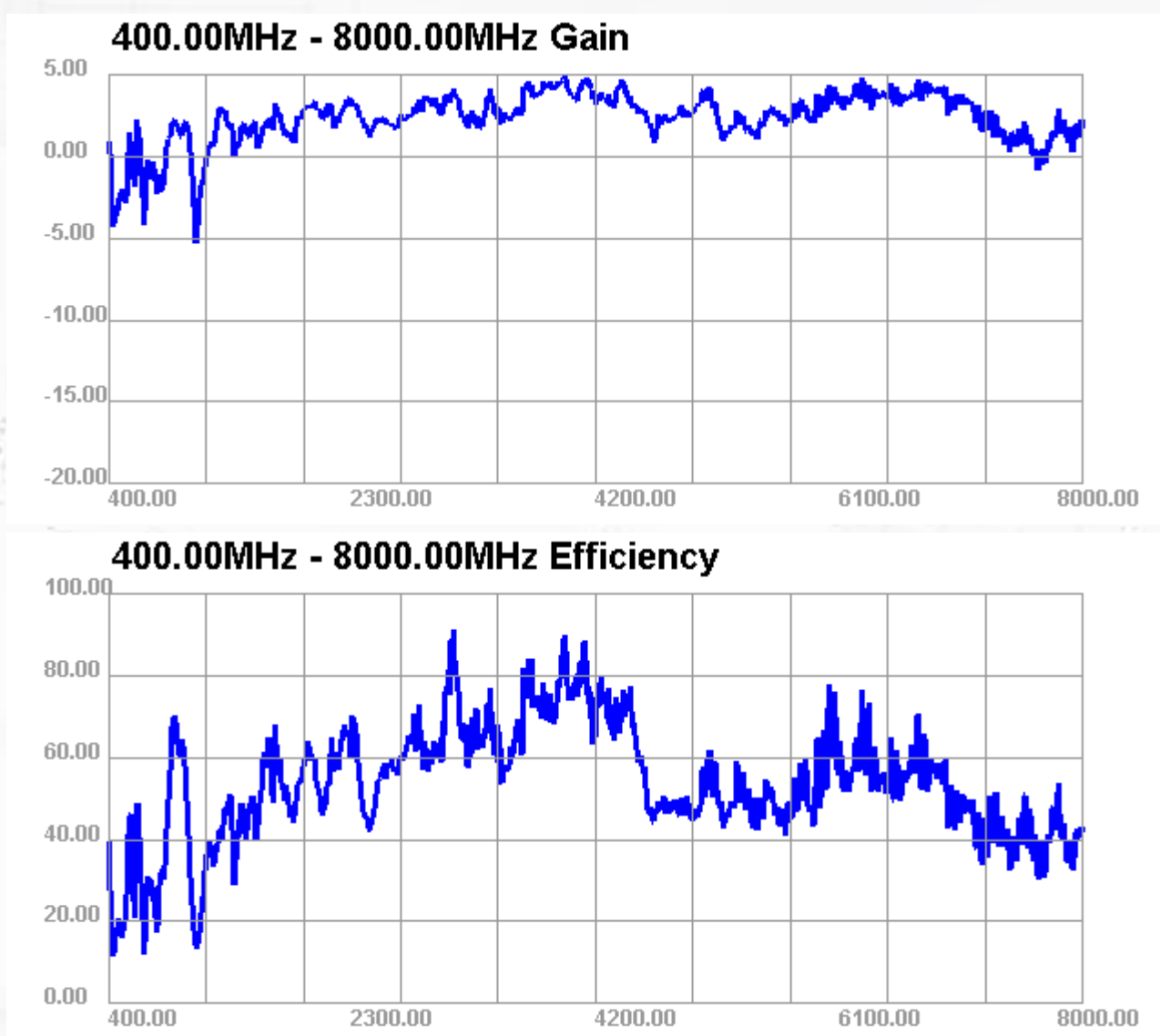

Maswell Cellular 5G/4G 8X8 MIMO Antenna Screw Mount IP67 UV stabilized L Plate Mount

AN_Master_Cubic-8C-LP

Measurement Gain Performance Antenna 4/Cable 4

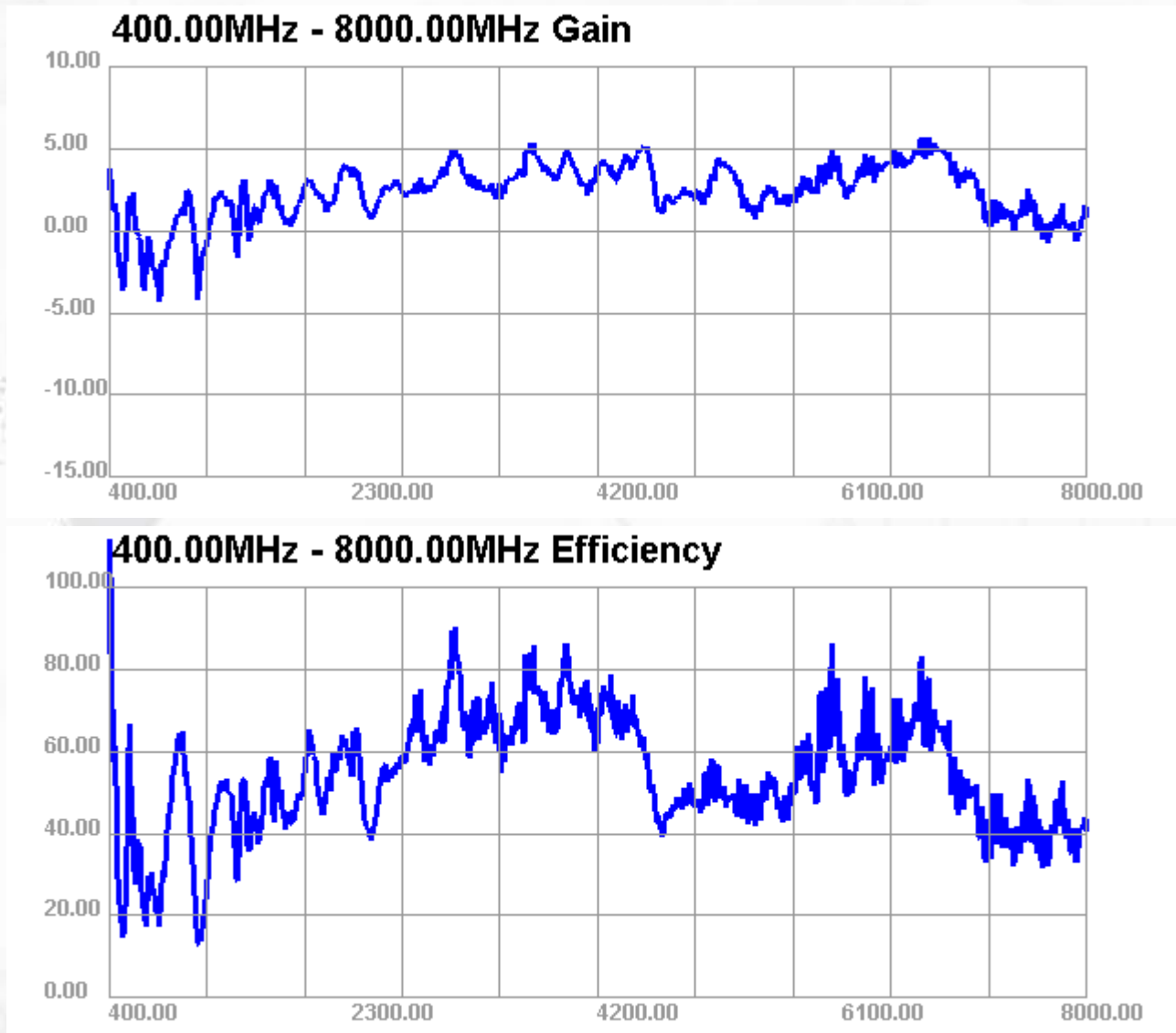

Maswell Cellular 5G/4G 8X8 MIMO Antenna Screw Mount IP67 UV stabilized L Plate Mount

AN_Master_Cubic-8C-LP

Measurement Gain Performance Antenna 5/Cable 5

400.00MHz - 8000.00MHz Gain



400.00MHz - 8000.00MHz Efficiency

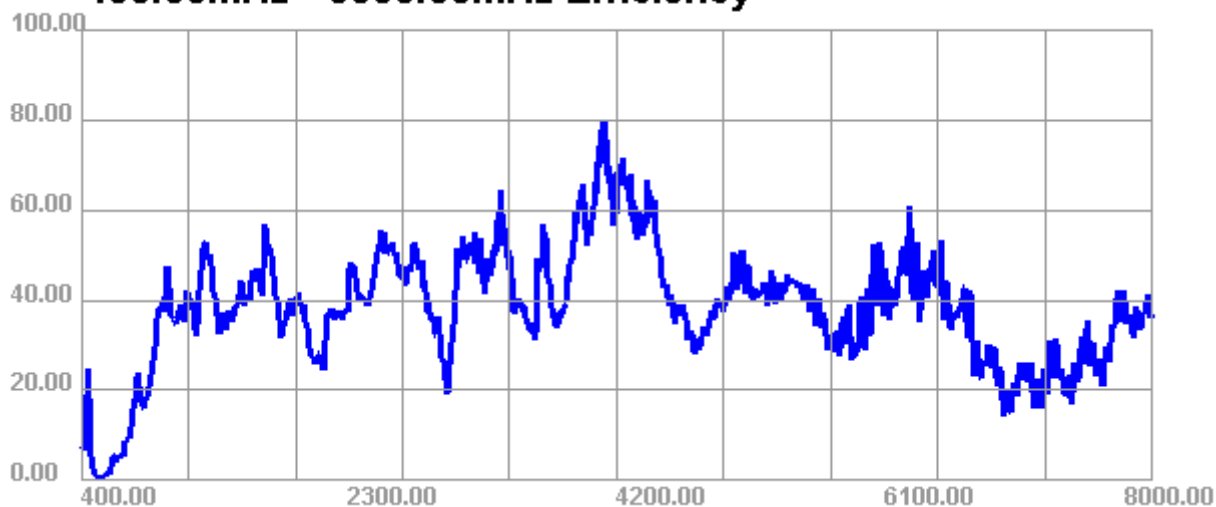

Maswell Cellular 5G/4G 8X8 MIMO Antenna Screw Mount IP67 UV stabilized L Plate Mount

AN_Master_Cubic-8C-LP

Measurement Gain Performance Antenna 6/Cable 6

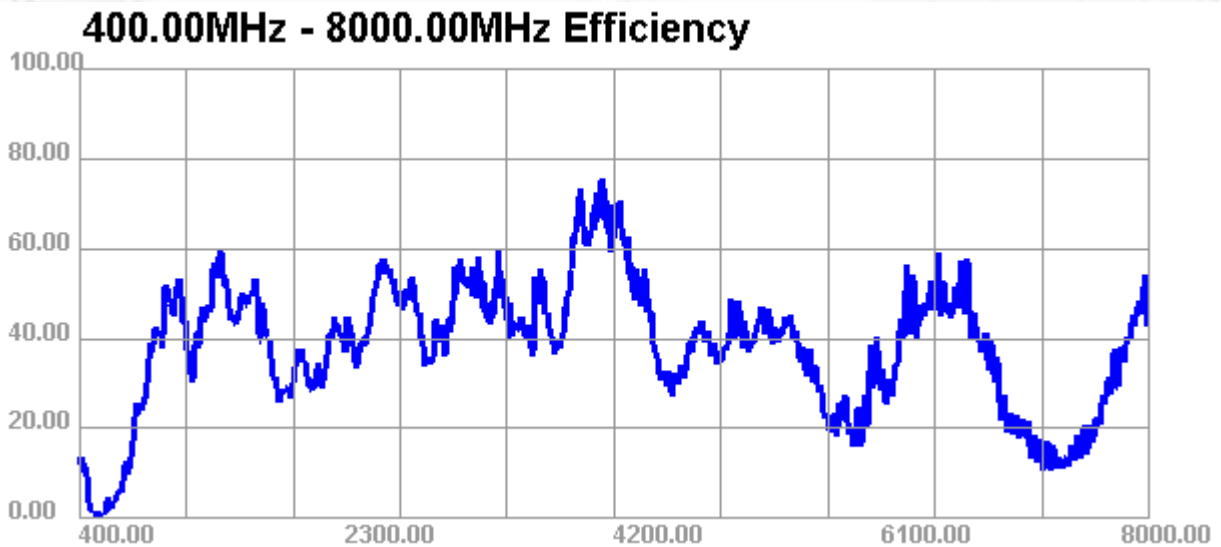
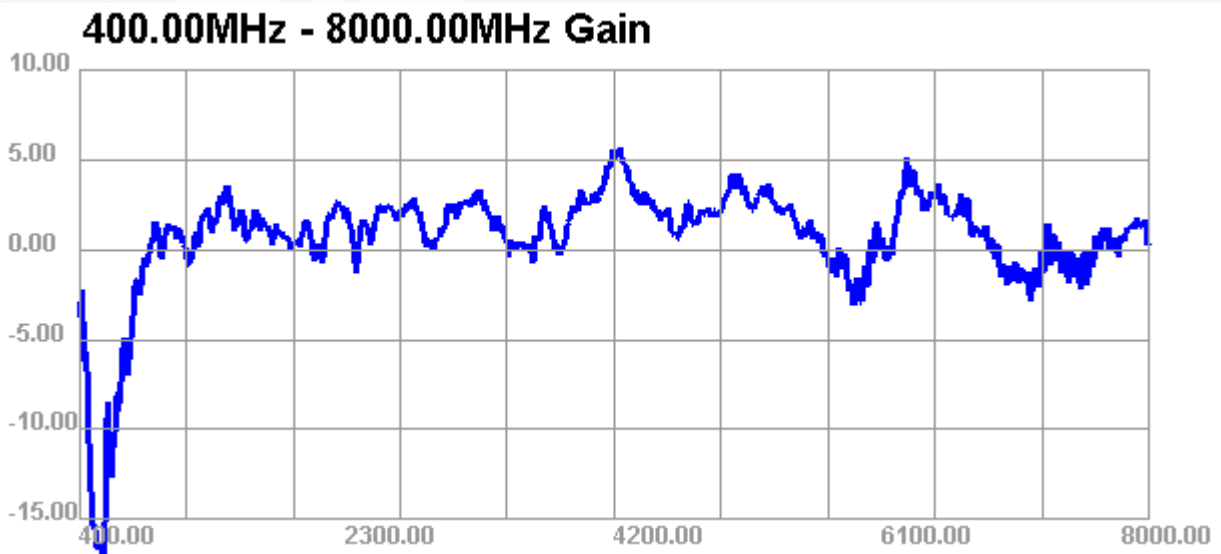

Maswell Cellular 5G/4G 8X8 MIMO Antenna Screw Mount IP67 UV stabilized L Plate Mount

AN_Master_Cubic-8C-LP

Measurement Gain Performance Antenna 7/Cable 7

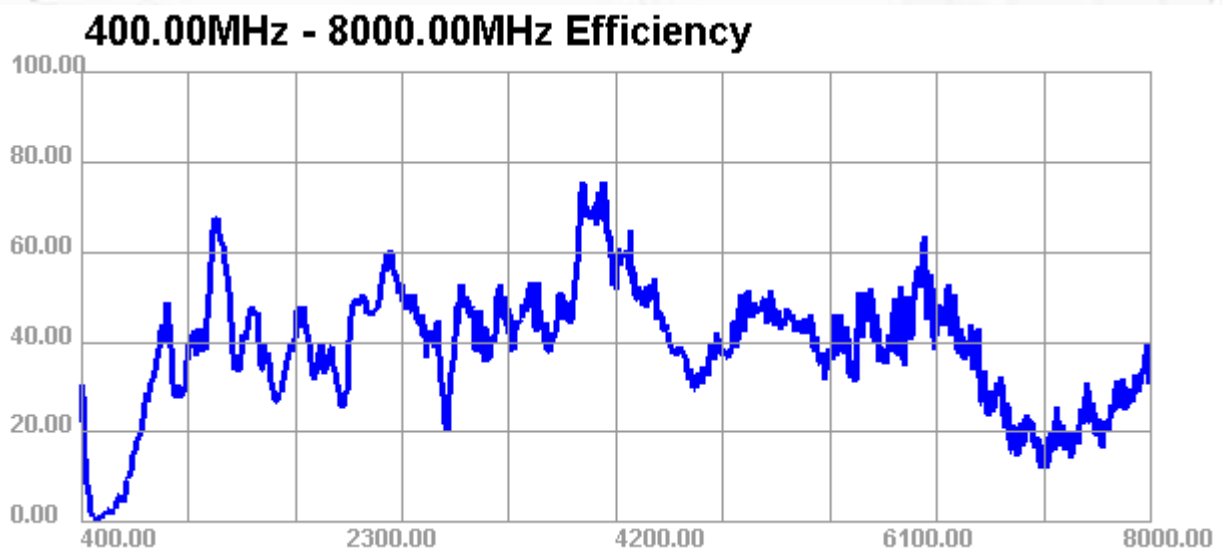
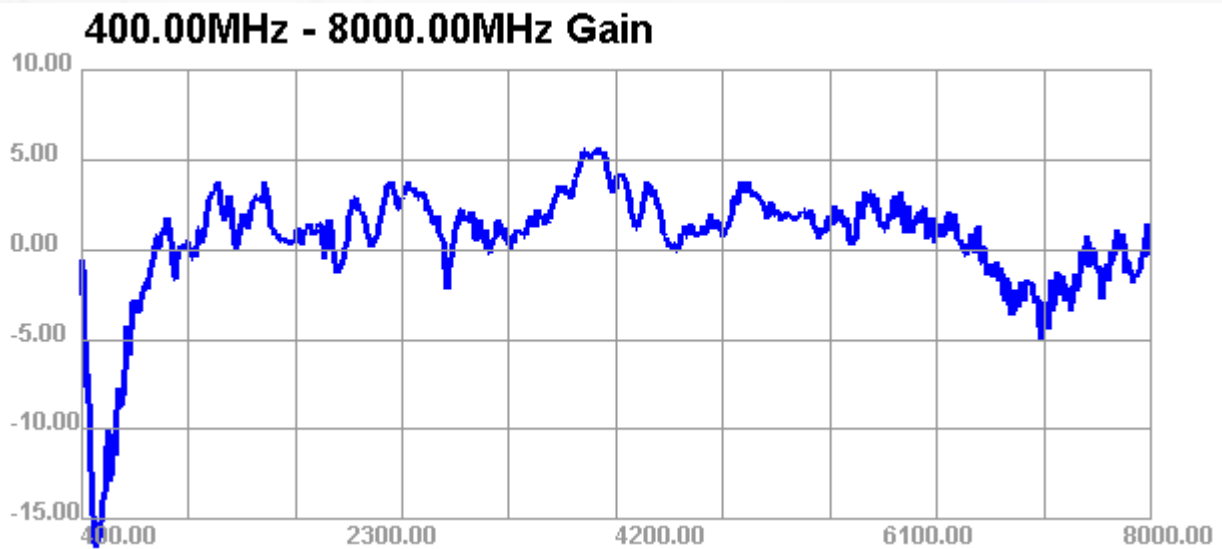

Maswell Cellular 5G/4G 8X8 MIMO Antenna Screw Mount IP67 UV stabilized L Plate Mount

AN_Master_Cubic-8C-LP

Measurement Gain Performance Antenna 8/Cable 8

400.00MHz - 8000.00MHz Gain



400.00MHz - 8000.00MHz Efficiency

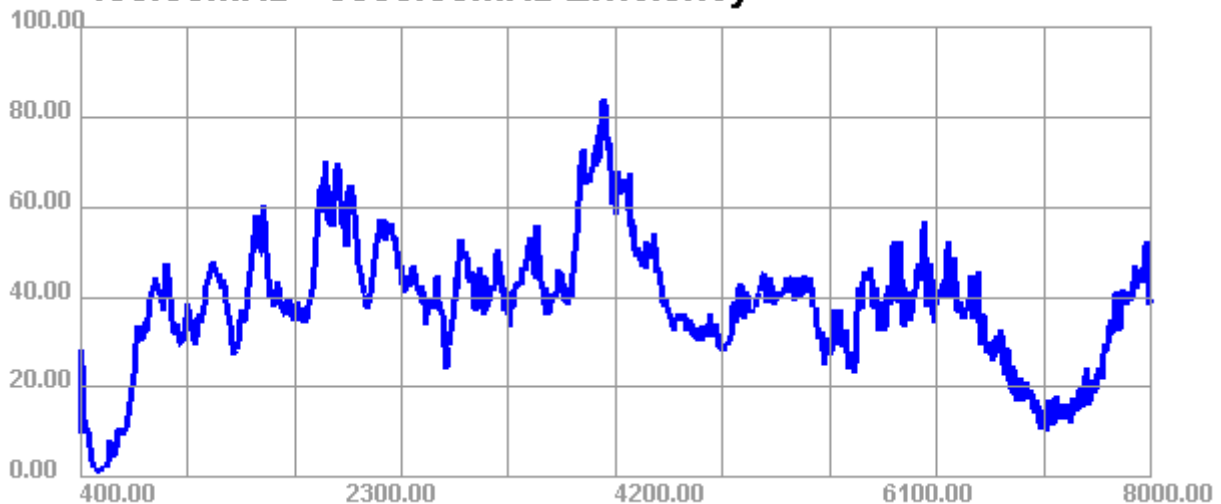

Maswell Cellular 5G/4G 8X8 MIMO Antenna

Screw Mount IP67 UV stabilized L Plate Mount

AN_Master_Cubic-8C-LP

Appendix : Measured Gain Performances Table

Antenna 1/Cable 1

Passive Test For 400-8000			
Freq	Effi	Effi	Gain
(MHz)	(%)	(dB)	(dBi)
600	26.99	-5.69	-0.72
650	16.04	-7.95	-4.48
700	16.26	-7.89	-4.04
750	19.31	-7.14	-3.04
800	31.21	-5.06	-2.12
850	36.86	-4.33	-0.96
900	53.34	-2.73	0.78
950	57.39	-2.41	1.12
1000	51.68	-2.87	1.42
1050	31.34	-5.04	-1.22
1100	20.94	-6.79	-4.12
1150	28.26	-5.49	-1.95
1200	38.18	-4.18	1.07
1250	40.27	-3.95	0.39
1300	43.55	-3.61	0.86
1350	37.83	-4.22	-0.14
1400	45.53	-3.42	1.21
1450	34.42	-4.63	-0.36
1500	49.11	-3.09	1.47
1550	38.41	-4.16	0.4
1600	56.95	-2.44	1.4
1650	63.77	-1.95	2.19
1700	71.1	-1.48	2.7
1750	52.92	-2.76	1.27
1800	48.82	-3.11	0.85
1850	46.55	-3.32	0.38
1900	49.8	-3.03	0.58
1950	59.78	-2.23	2.34

Passive Test For 400-8000			
Freq	Effi	Effi	Gain
(MHz)	(%)	(dB)	(dBi)
2000	54.81	-2.61	2.27
2050	42.74	-3.69	1.36
2100	45.63	-3.41	1.18
2150	53.89	-2.69	2.11
2200	55.54	-2.55	3.03
2250	60.96	-2.15	3.34
2300	65.2	-1.86	3.62
2350	51.9	-2.85	2.03
2400	41.21	-3.85	1.22
2450	43.87	-3.58	0.87
2500	53.58	-2.71	1.57
2550	58.4	-2.34	1.99
2600	54.25	-2.66	1.31
2650	59.22	-2.28	1.87
2700	60.28	-2.2	2.33
2750	63.64	-1.96	3.19
2800	63.67	-1.96	3.12
2850	56.22	-2.5	3.32
2900	58.29	-2.34	4.25
2950	64.73	-1.89	3.92
3000	58.93	-2.3	3.83
3050	75.1	-1.24	4.25
3100	79.99	-0.97	4.86
3150	65.16	-1.86	4.19
3200	59.95	-2.22	3.4
3250	71.56	-1.45	3.62
3300	64.04	-1.94	2.86
3350	68.49	-1.64	2.76
3400	63.15	-2	2.61
3450	49.35	-3.07	1.4
3500	58.1	-2.36	1.4

Suzhou maswell communication technology co. Ltd

Add: Floor 3, Building 6, No. 88 Zhenbei Road, High-tech District, Suzhou 215153, Jiangsu, China

Http://www.maswelltech.com

E-mail: Sales@maswelltech.com

Maswell Cellular 5G/4G 8X8 MIMO Antenna

Screw Mount IP67 UV stabilized L Plate Mount

AN_Master_Cubic-8C-LP

Appendix : Measured Gain Performances Table

Antenna 1/Cable 1

Passive Test For 400-8000			
Freq	Effi	Effi	Gain
(MHz)	(%)	(dB)	(dBi)
3550	61.28	-2.13	1.84
3600	66.01	-1.8	2.54
3650	79.93	-0.97	3.9
3700	87.49	-0.58	4.78
3750	77.61	-1.1	4.6
3800	72.59	-1.39	4.47
3850	72.82	-1.38	4.21
3900	72.62	-1.39	3.69
3950	86.67	-0.62	4.23
4000	74.37	-1.29	3.08
4050	74.39	-1.28	3.62
4100	79.51	-1	4.06
4150	75.05	-1.25	3.36
4200	62.45	-2.04	2.94
4250	65.5	-1.84	3.53
4300	69.34	-1.59	4.51
4350	61.65	-2.1	4.22
4400	74.6	-1.27	4.06
4450	70.06	-1.55	3.14
4500	59.5	-2.25	2.89
4550	45.74	-3.4	2.83
4600	45.14	-3.45	1.31
4650	52.73	-2.78	1.8
4700	46.69	-3.31	2.03
4750	40.3	-3.95	1.24
4800	43.97	-3.57	2.2
4850	40.98	-3.87	1.93
4900	40.25	-3.95	1.44
4950	39.23	-4.06	1.08
5000	40.67	-3.91	1.07

Passive Test For 400-8000			
Freq	Effi	Effi	Gain
(MHz)	(%)	(dB)	(dBi)
5050	45.34	-3.44	2.24
5100	44.01	-3.56	2.8
5150	42.65	-3.7	2.3
5200	44.86	-3.48	1.26
5250	51.36	-2.89	1.96
5300	52.49	-2.8	1.72
5350	45.58	-3.41	1.09
5400	41.99	-3.77	0.97
5450	43.68	-3.6	0.88
5500	44.26	-3.54	1.77
5550	44.85	-3.48	2.78
5600	41.48	-3.82	2.94
5650	43.52	-3.61	2.96
5700	46.43	-3.33	3.07
5750	46.99	-3.28	2.95
5800	41.93	-3.77	2.4
5850	37.46	-4.26	2.15
5900	38.98	-4.09	2.24
5950	50.92	-2.93	3.7
6000	52.04	-2.84	4.67
6050	55.07	-2.59	5.18
6100	47.49	-3.23	3.86
6150	46.63	-3.31	3.55
6200	45.72	-3.4	3.01
6250	43.66	-3.6	2.99
6300	46.82	-3.3	3.46
6350	50.38	-2.98	3.34
6400	52.05	-2.84	3.38

Maswell Cellular 5G/4G 8X8 MIMO Antenna Screw Mount IP67 UV stabilized L Plate Mount

AN_Master_Cubic-8C-LP

Appendix : Measured Gain Performances Table

Antenna 1/Cable 1

Passive Test For 400-8000			
Freq (MHz)	Effi (%)	Effi (dB)	Gain (dBi)
6450	50.2	-2.99	3.49
6500	52.94	-2.76	3.95
6550	54.07	-2.67	4
6600	56.21	-2.5	3.77
6650	57.25	-2.42	4.15
6700	57.96	-2.37	3.73
6750	56.87	-2.45	3.65
6800	50.4	-2.98	3.51
6850	45.83	-3.39	3.22
6900	41.47	-3.82	2.53
6950	37.24	-4.29	2.45
7000	39.95	-3.99	3.29
7050	35.9	-4.45	3.02
7100	30.86	-5.11	1.92
7150	28.47	-5.46	1.34
7200	29.41	-5.31	1.43
7250	28.01	-5.53	1.28
7300	28.41	-5.47	1.18
7350	30.89	-5.1	0.59
7400	36.53	-4.37	1.04
7450	36.33	-4.4	0.01
7500	29.7	-5.27	-1.08
7550	28.45	-5.46	-1.12
7600	29.74	-5.27	-0.41
7650	32.61	-4.87	-0.11
7700	38.86	-4.11	0.97
7750	39.2	-4.07	1.14
7800	36.01	-4.44	0.89
7850	33.86	-4.7	0.64
7900	37.18	-4.3	1.41
7950	37.27	-4.29	0.93
8000	29.07	-5.37	-0.04

Maswell Cellular 5G/4G 8X8 MIMO Antenna

Screw Mount IP67 UV stabilized L Plate Mount

AN_Master_Cubic-8C-LP

Appendix : Measured Gain Performances Table

Antenna 2/Cable 2

Passive Test For 400-8000			
Freq	Effi	Effi	Gain
(MHz)	(%)	(dB)	(dBi)
600	33.92	-4.7	-0.55
650	23.15	-6.35	-2.35
700	18.04	-7.44	-2.87
750	21.82	-6.61	-2.1
800	31.59	-5	-2.51
850	38.02	-4.2	-0.4
900	49.91	-3.02	-0.25
950	61.33	-2.12	0.89
1000	59.2	-2.28	1.12
1050	27.32	-5.64	-1.38
1100	12.6	-9	-2.57
1150	28.76	-5.41	-1.28
1200	27.25	-5.65	-0.87
1250	34.3	-4.65	0.65
1300	41.85	-3.78	2.14
1350	50.83	-2.94	2.71
1400	36.06	-4.43	0.85
1450	42.85	-3.68	1.62
1500	37.68	-4.24	-0.32
1550	38.44	-4.15	-0.6
1600	54.54	-2.63	0.84
1650	65.7	-1.82	1.95
1700	67.6	-1.7	2.49
1750	50.47	-2.97	1.9
1800	44.69	-3.5	1.27
1850	46.82	-3.3	1.26
1900	52.21	-2.82	1.66
1950	57.71	-2.39	2.73
2000	55.85	-2.53	3.26
2050	49.25	-3.08	2.7
2100	53.55	-2.71	1.32
2150	61.7	-2.1	2.84

Passive Test For 400-8000			
Freq	Effi	Effi	Gain
(MHz)	(%)	(dB)	(dBi)
2200	55.93	-2.52	3.23
2250	61.14	-2.14	2.87
2300	65.96	-1.81	2.8
2350	58.93	-2.3	2.63
2400	47.93	-3.19	2.87
2450	43.82	-3.58	0.33
2500	54.16	-2.66	2.15
2550	64.13	-1.93	2.54
2600	58.71	-2.31	2.48
2650	59.31	-2.27	2.44
2700	61.67	-2.1	3.12
2750	61.85	-2.09	2.65
2800	64.05	-1.93	2.25
2850	59.81	-2.23	2.3
2900	62.88	-2.01	3.1
2950	63.65	-1.96	2.83
3000	56.83	-2.45	2.46
3050	75.09	-1.24	3.41
3100	76.71	-1.15	3.19
3150	65.36	-1.85	2.8
3200	60.14	-2.21	2.35
3250	69.45	-1.58	3.61
3300	62.97	-2.01	3.6
3350	70.45	-1.52	3.4
3400	66.37	-1.78	2.25
3450	52.14	-2.83	1.4
3500	55.57	-2.55	1.61
3550	58.83	-2.3	1.8
3600	60.8	-2.16	2.23
3650	77.03	-1.13	3.05
3700	80.46	-0.94	3.85
3750	70.79	-1.5	3.7
3800	73.02	-1.37	3.92

Maswell Cellular 5G/4G 8X8 MIMO Antenna

Screw Mount IP67 UV stabilized L Plate Mount

AN_Master_Cubic-8C-LP

Appendix : Measured Gain Performances Table

Antenna 2/Cable 2

Passive Test For 400-8000			
Freq	Effi	Effi	Gain
(MHz)	(%)	(dB)	(dBi)
3850	75.95	-1.19	4.03
3900	77.7	-1.1	4.37
3950	94.28	-0.26	4.64
4000	80.04	-0.97	3.97
4050	81.48	-0.89	3.8
4100	85.26	-0.69	4.16
4150	81.67	-0.88	4.47
4200	69.41	-1.59	4.08
4250	74.84	-1.26	3.08
4300	75.39	-1.23	3.04
4350	61.94	-2.08	2.78
4400	73	-1.37	4.6
4450	75.65	-1.21	5.37
4500	64.37	-1.91	4.45
4500	64.37	-1.91	4.45
4550	55.6	-2.55	3.79
4600	46.35	-3.34	2.25
4650	41.93	-3.77	1.39
4700	43.43	-3.62	2.2
4750	42.47	-3.72	2.14
4800	45.87	-3.38	1.84
4850	45.4	-3.43	2.01
4900	45.56	-3.41	2.18
4950	42.17	-3.75	1.71
5000	43.27	-3.64	1.88
5010	44.92	-3.48	2.11
5050	54.25	-2.66	3.53

Passive Test For 400-8000			
Freq	Effi	Effi	Gain
(MHz)	(%)	(dB)	(dBi)
5100	55.97	-2.52	4.17
5150	48.42	-3.15	3.86
5200	40.49	-3.93	3.52
5250	41.3	-3.84	3.15
5300	51.39	-2.89	3.24
5350	51.9	-2.85	3.23
5400	45.79	-3.39	2.55
5450	44.61	-3.51	2.38
5500	43.99	-3.57	2.14
5550	48.33	-3.16	2.53
5600	44.63	-3.5	1.95
5650	41.77	-3.79	2.1
5700	41.26	-3.84	2.13
5750	46.13	-3.36	1.89
5800	51.43	-2.89	1.83
5850	49.08	-3.09	1.59
5900	37.19	-4.3	0.92
5950	39.21	-4.07	1.44
6000	44.29	-3.54	2.08
6050	60.44	-2.19	3.2
6100	56.47	-2.48	2.98
6150	53.32	-2.73	3.01
6200	53.11	-2.75	2.76
6250	56.63	-2.47	2.9
6300	59.47	-2.26	3.5
6350	54.33	-2.65	3.69
6400	51.68	-2.87	3.57
6450	56.35	-2.49	4.04
6500	68.79	-1.62	4.48
6550	69.33	-1.59	4.55
6600	62.7	-2.03	4.35

Maswell Cellular 5G/4G 8X8 MIMO Antenna Screw Mount IP67 UV stabilized L Plate Mount

AN_Master_Cubic-8C-LP

Appendix : Measured Gain Performances Table Antenna 2/Cable 2

Passive Test For 400-8000			
Freq (MHz)	Effi (%)	Effi (dB)	Gain (dBi)
6650	59.2	-2.28	4.3
6700	62.92	-2.01	5.01
6750	61.23	-2.13	4.53
6800	55.25	-2.58	4.05
6850	56.58	-2.47	4.03
6900	55.75	-2.54	3.92
6950	45.98	-3.37	2.91
7000	40.29	-3.95	2.71
7050	39.26	-4.06	1.82
7100	42.46	-3.72	1.88
7150	43.76	-3.59	2.15
7200	39.72	-4.01	1.53
7250	32.57	-4.87	0.94
7300	32.44	-4.89	1.11
7350	34.02	-4.68	0.54
7400	36.69	-4.35	0.22
7450	40.95	-3.88	0.91
7500	44.15	-3.55	1.23
7550	50.84	-2.94	1.48
7600	47.05	-3.27	0.43
7650	38.91	-4.1	0.35
7700	37.71	-4.24	0.34
7750	43.31	-3.63	1.28
7800	47.08	-3.27	1.74
7850	45.72	-3.4	1.35
7900	44.52	-3.51	1.16
7950	48.02	-3.19	1.53
8000	46.63	-3.31	1.49

Maswell Cellular 5G/4G 8X8 MIMO Antenna

Screw Mount IP67 UV stabilized L Plate Mount

AN_Master_Cubic-8C-LP

Appendix : Measured Gain Performances Table

Antenna 3/Cable 3

Passive Test For 400-8000			
Freq	Effi	Effi	Gain
(MHz)	(%)	(dB)	(dBi)
600	21.16	-6.74	-1.84
650	29.47	-5.31	-1.13
700	27.62	-5.59	-0.39
750	26.5	-5.77	-0.37
800	31.9	-4.96	-1.09
850	40.98	-3.87	0.51
900	68.71	-1.63	2.18
950	60.57	-2.18	1.53
1000	57.11	-2.43	2.06
1050	25.18	-5.99	-0.9
1100	15.67	-8.05	-3.36
1150	32.21	-4.92	-0.67
1200	38.42	-4.15	0.9
1250	38.77	-4.12	2.28
1300	45.38	-3.43	2.81
1350	51.15	-2.91	1.92
1400	38.58	-4.14	0.72
1450	48.19	-3.17	1.96
1500	46.96	-3.28	1.18
1550	40.07	-3.97	1.34
1600	55.75	-2.54	1.55
1650	64.93	-1.88	2.31
1700	68.09	-1.67	3.21
1750	53.56	-2.71	1.97
1800	50.02	-3.01	1.23
1850	46.17	-3.36	0.84
1900	54.07	-2.67	2.29
1950	61.92	-2.08	2.93
2000	59.83	-2.23	3.35

Passive Test For 400-8000			
Freq	Effi	Effi	Gain
(MHz)	(%)	(dB)	(dBi)
2050	50.34	-2.98	2.82
2100	52.18	-2.83	2.78
2150	60.55	-2.18	2.3
2200	58.83	-2.3	2.3
2250	66.46	-1.77	3.26
2300	70.25	-1.53	3.5
2350	57.45	-2.41	2.66
2400	45.46	-3.42	1.77
2450	44.76	-3.49	1.58
2500	54.04	-2.67	2.32
2550	58.49	-2.33	2.28
2600	57.64	-2.39	1.89
2650	55.65	-2.55	1.74
2700	59.83	-2.23	2.27
2750	63.26	-1.99	2.4
2800	61.36	-2.12	2.65
2850	57.28	-2.42	2.74
2900	60.87	-2.16	3.53
2950	63.22	-1.99	3.47
3000	58.87	-2.3	2.52
3050	81.32	-0.9	3.73
3100	83.49	-0.78	3.82
3150	65.47	-1.84	2.6
3200	57.32	-2.42	1.75
3250	68.1	-1.67	2.53
3300	65.91	-1.81	1.73
3350	72.64	-1.39	3.46
3400	67.25	-1.72	3.24
3450	53.77	-2.69	1.96
3500	57.65	-2.39	2.48

Maswell Cellular 5G/4G 8X8 MIMO Antenna

Screw Mount IP67 UV stabilized L Plate Mount

AN_Master_Cubic-8C-LP

Appendix : Measured Gain Performances Table

Antenna 3/Cable 3

Passive Test For 400-8000			
Freq	Effi	Effi	Gain
(MHz)	(%)	(dB)	(dBi)
3500	57.65	-2.39	2.48
3550	60.34	-2.19	2.37
3600	63.69	-1.96	2.55
3650	79.01	-1.02	4.23
3700	83.82	-0.77	4.35
3750	75.15	-1.24	3.82
3800	75.15	-1.24	4.4
3850	75.42	-1.23	4.55
3900	73.74	-1.32	4.31
3950	88.92	-0.51	4.82
4000	75.61	-1.21	3.89
4050	79.6	-0.99	3.47
4100	84.11	-0.75	4.55
4150	77.58	-1.1	4.63
4200	65.3	-1.85	3.19
4250	75.41	-1.23	3.53
4300	76.62	-1.16	3.75
4350	64.74	-1.89	3.13
4400	73.35	-1.35	4.68
4450	74.34	-1.29	3.63
4500	68.42	-1.65	3.23
4550	60.48	-2.18	2.89
4600	49.2	-3.08	2.22
4650	44.47	-3.52	1.18
4700	47.18	-3.26	2.09
4750	46.16	-3.36	2.1
4800	48.43	-3.15	2.26
4850	45.89	-3.38	2.61
4900	46.91	-3.29	2.52
4950	44.68	-3.5	2.6

Passive Test For 400-8000			
Freq	Effi	Effi	Gain
(MHz)	(%)	(dB)	(dBi)
5000	45.67	-3.4	3.14
5010	47.77	-3.21	3.25
5020	48.36	-3.16	3.29
5030	56.26	-2.5	3.98
5040	57.57	-2.4	4.01
5050	55.7	-2.54	3.86
5100	56.22	-2.5	3.63
5150	50.33	-2.98	2.29
5200	42.83	-3.68	0.97
5250	48.25	-3.17	1.71
5300	59.2	-2.28	2.72
5350	56.6	-2.47	2.45
5400	48.41	-3.15	1.71
5450	46.34	-3.34	1.42
5500	45.61	-3.41	1.9
5550	50.42	-2.97	2.58
5600	46.01	-3.37	2.5
5650	45.72	-3.4	2.46
5700	49.06	-3.09	2.37
5750	54.89	-2.61	3.17
5800	58.91	-2.3	3.47
5850	53.93	-2.68	2.68
5900	42.99	-3.67	2
5950	47.86	-3.2	2.43
6000	51.93	-2.85	2.72

Maswell Cellular 5G/4G 8X8 MIMO Antenna

Screw Mount IP67 UV stabilized L Plate Mount

AN_Master_Cubic-8C-LP

Appendix : Measured Gain Performances Table

Antenna 3/Cable 3

Passive Test For 400-8000			
Freq	Effi	Effi	Gain
(MHz)	(%)	(dB)	(dBi)
6050	67.04	-1.74	3.68
6100	60.33	-2.19	3.41
6150	56.91	-2.45	3.66
6200	56.57	-2.47	3.64
6250	56.76	-2.46	3.69
6300	56.45	-2.48	3.33
6350	51.77	-2.86	2.86
6400	51.57	-2.88	3.47
6450	56.33	-2.49	3.86
6500	64.99	-1.87	4.44
6550	61.58	-2.11	4.18
6600	56.73	-2.46	3.75
6650	56.78	-2.46	3.55
6700	60.74	-2.17	3.85
6750	58.59	-2.32	3.8
6800	54.46	-2.64	3.81
6850	56.76	-2.46	4.07
6900	53.67	-2.7	3.73
6950	42.83	-3.68	2.53
7000	42.25	-3.74	2.88
7050	46.61	-3.32	3.42
7100	49.7	-3.04	3.46
7150	44.96	-3.47	2.8
7200	39.68	-4.01	2.31
7250	37.78	-4.23	1.86
7300	39.18	-4.07	1.15

Passive Test For 400-8000			
Freq	Effi	Effi	Gain
(MHz)	(%)	(dB)	(dBi)
7350	38.5	-4.15	1.1
7400	38.27	-4.17	0.87
7450	39.58	-4.03	1.45
7500	44.98	-3.47	1.62
7550	50.86	-2.94	1.98
7600	41.2	-3.85	0.52
7650	30.7	-5.13	-0.89
7700	30.88	-5.1	-0.41
7750	40.98	-3.87	0.91
7800	48.5	-3.14	1.7
7850	44.12	-3.55	2.22
7900	39.31	-4.05	1.81
7950	42.62	-3.7	2.01
8000	41.62	-3.81	1.65

Maswell Cellular 5G/4G 8X8 MIMO Antenna

Screw Mount IP67 UV stabilized L Plate Mount

AN_Master_Cubic-8C-LP

Appendix : Measured Gain Performances Table

Antenna4 /Cable 4

Passive Test For 400-8000			
Freq (MHz)	Effi (%)	Effi (dB)	Gain (dBi)
400	83.57	-0.78	2.51
450	61.07	-2.14	1.66
500	17.62	-7.54	-3.02
500	17.62	-7.54	-3.02
550	55.16	-2.58	1.38
600	27.78	-5.56	0.55
650	26.09	-5.84	-1.91
700	25.93	-5.86	-0.81
750	25.05	-6.01	-2.41
800	22.23	-6.53	-3.79
850	39.44	-4.04	-1.13
900	54.75	-2.62	0.03
950	64.42	-1.91	0.93
1000	55.18	-2.58	2.17
1050	33.95	-4.69	0.73
1100	13.27	-8.77	-3.22
1150	23.66	-6.26	-0.98
1200	41.94	-3.77	1.11
1250	49.68	-3.04	1.93
1300	52.8	-2.77	2.04
1350	49.64	-3.04	1.8
1400	28.54	-5.45	-1.63
1450	53.26	-2.74	3.16
1500	37.01	-4.32	-0.14
1500	37.01	-4.32	-0.14
1550	40.6	-3.91	0.96
1600	48.1	-3.18	1.71
1650	58.55	-2.32	3.18
1700	57.8	-2.38	2.72
1750	45.53	-3.42	0.91
1800	43.29	-3.64	0.39

Passive Test For 400-8000			
Freq (MHz)	Effi (%)	Effi (dB)	Gain (dBi)
1850	45.73	-3.4	1.11
1900	48.91	-3.11	2.07
1950	61.93	-2.08	3.03
2000	58.7	-2.31	2.53
2050	46.55	-3.32	2.17
2100	53.86	-2.69	1.58
2150	57	-2.44	1.8
2200	59.26	-2.27	3.33
2250	60.09	-2.21	3.81
2300	64.64	-1.89	3.84
2350	57.74	-2.39	2.89
2400	41.65	-3.8	1.29
2450	40.8	-3.89	0.89
2500	50.86	-2.94	1.99
2550	56.98	-2.44	2.74
2600	53.54	-2.71	2.61
2650	55.77	-2.54	2.78
2700	57.19	-2.43	2.22
2750	63.98	-1.94	2.32
2800	64.41	-1.91	2.28
2850	57.49	-2.4	2.33
2900	61.8	-2.09	2.83
2950	65.04	-1.87	3.18
3000	61.96	-2.08	3.29
3050	82.05	-0.86	4.57
3100	83.48	-0.78	4.45
3150	67.21	-1.73	3.67
3200	58.37	-2.34	2.74
3250	69.68	-1.57	3
3300	67.75	-1.69	2.76

Maswell Cellular 5G/4G 8X8 MIMO Antenna Screw Mount IP67 UV stabilized L Plate Mount

AN_Master_Cubic-8C-LP

Appendix : Measured Gain Performances Table

Antenna4 /Cable 4

Passive Test For 400-8000			
Freq (MHz)	Effi (%)	Effi (dB)	Gain (dBi)
3100	83.48	-0.78	4.45
3150	67.21	-1.73	3.67
3200	58.37	-2.34	2.74
3250	69.68	-1.57	3
3300	67.75	-1.69	2.76
3350	73.05	-1.36	2.66
3400	68.44	-1.65	2.45
3450	54.83	-2.61	1.9
3500	63.42	-1.98	3.19
3550	64.35	-1.91	3.18
3600	65.65	-1.83	3.41
3650	80.99	-0.92	4.84
3700	85.65	-0.67	5.32
3750	75	-1.25	4.3
3800	71.14	-1.48	3.87
3850	70.36	-1.53	3.54
3900	71.7	-1.45	3.51
3950	86.29	-0.64	4.78
4000	74.9	-1.25	4.21
4050	73.39	-1.34	3.37
4100	74.13	-1.3	2.77
4150	71.49	-1.46	3.11
4200	61.8	-2.09	3.45
4250	73.33	-1.35	4.16
4300	78.64	-1.04	3.97
4350	64.22	-1.92	3.03
4400	70.02	-1.55	4.44
4450	69.52	-1.58	4.17

Passive Test For 400-8000			
Freq (MHz)	Effi (%)	Effi (dB)	Gain (dBi)
4500	67.98	-1.68	4.64
4550	63.47	-1.97	5.18
4600	53.08	-2.75	4.44
4650	45.51	-3.42	2.14
4700	39.23	-4.06	1.04
4750	43.65	-3.6	2
4800	46.84	-3.29	1.84
4850	46.06	-3.37	2.16
4900	47.93	-3.19	2.21
4950	46.58	-3.32	1.97
5000	45.09	-3.46	1.78
5050	52.51	-2.8	2.41
5060	46.88	-3.29	2.06
5070	55.14	-2.59	2.95
5080	57.65	-2.39	3.28
5090	58.2	-2.35	3.52
5100	52.69	-2.78	3.32
5150	49.2	-3.08	3.96
5200	46.6	-3.32	3.81
5250	49.81	-3.03	3.66
5300	53.32	-2.73	3.12
5350	51.94	-2.85	2.01
5400	46.79	-3.3	1.36
5450	46.3	-3.34	1.36
5500	48.29	-3.16	2.06
5550	51.06	-2.92	2.42
5600	45.88	-3.38	1.62
5650	46.17	-3.36	2.03
5700	51.58	-2.88	2.11

Maswell Cellular 5G/4G 8X8 MIMO Antenna Screw Mount IP67 UV stabilized L Plate Mount

AN_Master_Cubic-8C-LP

Appendix : Measured Gain Performances Table Antenna4 /Cable 4

Passive Test For 400-8000				Passive Test For 400-8000			
Freq (MHz)	Effi (%)	Effi (dB)	Gain (dBi)	Freq (MHz)	Effi (%)	Effi (dB)	Gain (dBi)
5750	61.18	-2.13	2.66	6950	49.3	-3.07	3.33
5800	62.77	-2.02	3.35	7000	44.57	-3.51	2.59
5850	58	-2.37	2.96	7050	47.83	-3.2	3.07
5900	47.06	-3.27	2.23	7100	51.57	-2.88	3.6
5950	54.95	-2.6	2.81	7150	46	-3.37	2.73
6000	60.48	-2.18	3.12	7200	39.61	-4.02	1.5
6050	70.71	-1.51	4.27	7250	36.1	-4.42	0.24
6100	59.93	-2.22	2.98	7300	37.54	-4.26	0.52
6150	55.39	-2.57	2.66	7350	36.5	-4.38	0.66
6200	55.42	-2.56	2.95	7400	38.1	-4.19	1.03
6250	58.18	-2.35	3.43	7450	40.06	-3.97	0.95
6300	58.34	-2.34	3.39	7500	45.15	-3.45	1.85
6350	51.93	-2.85	2.94	7550	52.08	-2.83	2.22
6400	52.31	-2.81	3.54	7600	41.54	-3.82	0.93
6450	59.65	-2.24	4.12	7650	32.88	-4.83	-0.13
6500	72.99	-1.37	5.07	7700	32.17	-4.92	-0.76
6550	72.93	-1.37	4.81	7750	39.97	-3.98	0.19
6600	66.96	-1.74	4.33	7800	48.83	-3.11	1.03
6650	66.51	-1.77	4.43	7850	43.71	-3.59	0.49
6700	71.93	-1.43	4.94	7900	41.09	-3.86	0.49
6750	68.09	-1.67	4.99	7950	41.53	-3.82	0.09
6800	62.42	-2.05	4.9	8000	40.1	-3.97	0.79
6850	65.61	-1.83	4.98				
6900	61.12	-2.14	4.56				

Maswell Cellular 5G/4G 8X8 MIMO Antenna Screw Mount IP67 UV stabilized L Plate Mount

AN_Master_Cubic-8C-LP

Appendix : Measured Gain Performances Table

Antenna5 /Cable 5

Passive Test For 400-8000			
Freq (MHz)	Effi (%)	Effi (dB)	Gain (dBi)
700	5.57	-12.54	-8.25
750	9.71	-10.13	-6.12
800	24.09	-6.18	-0.56
850	17.07	-7.68	-3.48
900	24.16	-6.17	-1.33
950	38.04	-4.2	-0.06
1000	43.77	-3.59	1.42
1050	35.7	-4.47	1.37
1100	39.18	-4.07	0.9
1150	42.01	-3.77	0.1
1200	36.26	-4.41	-0.97
1250	45.91	-3.38	1.84
1300	49.95	-3.01	1.26
1350	40.87	-3.89	0.21
1400	36.88	-4.33	-0.32
1450	37.79	-4.23	-0.58
1500	38.5	-4.14	0.05
1550	41.55	-3.81	0.17
1600	41.9	-3.78	-0.61
1650	47.24	-3.26	2.14
1700	56.58	-2.47	2.68
1750	49.95	-3.01	1.16
1800	38.72	-4.12	-0.25
1850	35.71	-4.47	1.34
1900	36.6	-4.36	0.93
1950	38.95	-4.1	0.41
2000	34.55	-4.62	-1.03
2050	26.57	-5.76	-1.61
2100	27.78	-5.56	-0.76
2150	37.39	-4.27	-0.17
2200	35.62	-4.48	-0.32

Passive Test For 400-8000			
Freq (MHz)	Effi (%)	Effi (dB)	Gain (dBi)
2250	35.89	-4.45	-0.17
2300	46.51	-3.32	1.6
2350	44.69	-3.5	1.83
2400	40.63	-3.91	1.2
2450	41.25	-3.85	0.52
2500	50.25	-2.99	2.06
2550	54.98	-2.6	3
2600	51.61	-2.87	3.94
2650	46.07	-3.37	3.17
2700	43.38	-3.63	2.71
2750	48.99	-3.1	3.24
2800	46.92	-3.29	2.93
2850	37.69	-4.24	2.68
2900	35.8	-4.46	2.33
2950	30.22	-5.2	0.31
3000	19.25	-7.16	-1.86
3050	39.88	-3.99	-0.19
3100	51.77	-2.86	1.39
3150	52.02	-2.84	2.01
3200	47.88	-3.2	2.04
3250	48.24	-3.17	2.93
3300	45.36	-3.43	2.7
3350	55.9	-2.53	3.45
3400	55.77	-2.54	2.99
3450	39.62	-4.02	0.96
3500	40.59	-3.92	1.07
3550	37.31	-4.28	0.88
3600	32.33	-4.9	0.46
3650	46.48	-3.33	1.81
3700	53.78	-2.69	2.44
3750	37.35	-4.28	0.07

Maswell Cellular 5G/4G 8X8 MIMO Antenna

Screw Mount IP67 UV stabilized L Plate Mount

AN_Master_Cubic-8C-LP

Appendix : Measured Gain Performances Table

Antenna5 /Cable 5

Passive Test For 400-8000			
Freq (MHz)	Effi (%)	Effi (dB)	Gain (dBi)
3800	36.31	-4.4	0.44
3850	45.37	-3.43	0.4
3900	53.25	-2.74	1.61
3950	64.36	-1.91	2.2
4000	56	-2.52	1.84
4050	66.38	-1.78	2.51
4100	77.2	-1.12	3.45
4150	69.68	-1.57	3.16
4200	59.2	-2.28	2.71
4250	67.35	-1.72	3.5
4300	67.99	-1.68	3.85
4350	54.29	-2.65	2.2
4400	58.5	-2.33	1.74
4450	60.02	-2.22	2.19
4500	50.96	-2.93	2.12
4550	43.75	-3.59	1.41
4600	39.23	-4.06	1.36
4650	38.01	-4.2	1.1
4700	31.44	-5.03	-0.26
4750	28.09	-5.51	-0.55
4800	31.55	-5.01	0.03
4850	34.19	-4.66	0.48
4900	37.5	-4.26	1.67
4950	37.82	-4.22	1.67
5000	40.31	-3.95	2.14
5010	42.76	-3.69	2.54
5020	44.31	-3.53	2.63
5030	50.57	-2.96	3.03
5040	49.69	-3.04	2.61
5050	46.97	-3.28	2.13

Passive Test For 400-8000			
Freq (MHz)	Effi (%)	Effi (dB)	Gain (dBi)
5100	46.49	-3.33	0.7
5150	41.98	-3.77	0.89
5200	40.55	-3.92	1.19
5250	44.12	-3.55	1.4
5300	46.75	-3.3	1.07
5350	43.43	-3.62	1.34
5400	41.75	-3.79	0.92
5450	43.92	-3.57	0.99
5500	43.26	-3.64	1
5550	43.58	-3.61	0.62
5600	38.54	-4.14	0.61
5650	33.96	-4.69	0.12
5700	29.13	-5.36	-0.26
5750	29.95	-5.24	-0.78
5800	34.84	-4.58	-0.33
5850	39.15	-4.07	1.01
5900	28.26	-5.49	0.19
5950	29.99	-5.23	0.95
6000	31.95	-4.96	1.59
6050	43.44	-3.62	3.09
6100	40.73	-3.9	2.07
6150	42.5	-3.72	1.89
6200	45.59	-3.41	2.46
6250	46.17	-3.36	3.22
6300	40.12	-3.97	2.65
6350	35.53	-4.49	1.97
6400	40.32	-3.94	2.14
6450	50.9	-2.93	3.39
6500	53.5	-2.72	2.75

Maswell Cellular 5G/4G 8X8 MIMO Antenna Screw Mount IP67 UV stabilized L Plate Mount

AN_Master_Cubic-8C-LP

Appendix : Measured Gain Performances Table Antenna5 /Cable 5

Passive Test For 400-8000			
Freq (MHz)	Effi (%)	Effi (dB)	Gain (dBi)
6550	42.45	-3.72	1.77
6600	36.72	-4.35	1.59
6650	38.46	-4.15	1.39
6700	36.22	-4.41	0.95
6750	28.83	-5.4	-0.24
6800	26.34	-5.79	-0.73
6850	28.47	-5.46	-0.05
6900	20.9	-6.8	-1.1
6950	14.12	-8.5	-1.77
7000	15.07	-8.22	-1.48
7050	23.02	-6.38	-0.24
7100	25.96	-5.86	-0.41
7150	20.15	-6.96	-1.65
7200	17.44	-7.58	-2.36
7250	19.1	-7.19	-2.41
7300	23	-6.38	-1.27
7350	22.98	-6.39	-1.24
7400	22.1	-6.56	-1.04
7450	26.24	-5.81	-0.11
7500	31.75	-4.98	1.29
7550	31.37	-5.04	2.16
7600	23.54	-6.28	1.11
7650	20.83	-6.81	0.57
7700	27.47	-5.61	1.03
7750	40.85	-3.89	2.38
7800	41.87	-3.78	1.76
7850	34.21	-4.66	0.34
7900	34.35	-4.64	0.47
7950	36.92	-4.33	0.69
8000	37.01	-4.32	0.48

Maswell Cellular 5G/4G 8X8 MIMO Antenna

Screw Mount IP67 UV stabilized L Plate Mount

AN_Master_Cubic-8C-LP

Appendix : Measured Gain Performances Table

Antenna6 /Cable 6

Passive Test For 400-8000			
Freq (MHz)	Effi (%)	Effi (dB)	Gain (dBi)
700	5.8	-12.37	-7.2
750	9.92	-10.04	-6.95
800	24.34	-6.14	-1.76
850	24.34	-6.14	-1.19
900	36.47	-4.38	-0.08
950	40.76	-3.9	1.42
1000	43.44	-3.62	0.22
1050	47.65	-3.22	1.1
1100	52.7	-2.78	1.26
1150	45.01	-3.47	0.23
1200	30.54	-5.15	-0.52
1250	38.05	-4.2	0.17
1300	45.14	-3.45	2.16
1350	55.22	-2.58	1.73
1400	59.91	-2.23	2.92
1450	51.2	-2.91	3.55
1500	43.21	-3.64	1.12
1550	49.43	-3.06	2.26
1600	48.17	-3.17	0.81
1650	53.25	-2.74	2.21
1700	47.71	-3.21	1.73
1750	39.36	-4.05	1.14
1800	31.53	-5.01	1.37
1850	28.22	-5.49	0.68
1900	26.93	-5.7	0.08
1950	35.24	-4.53	0.24
2000	35.04	-4.55	1.47
2050	28.99	-5.38	0.52

Passive Test For 400-8000			
Freq (MHz)	Effi (%)	Effi (dB)	Gain (dBi)
2100	34.61	-4.61	0.35
2150	33.7	-4.72	0.86
2200	40.6	-3.91	1.74
2250	40.65	-3.91	2.46
2300	45.01	-3.47	2.27
2350	37.4	-4.27	0.1
2400	38.7	-4.12	1.23
2450	41.74	-3.79	1.19
2500	50.87	-2.94	1.46
2550	57.57	-2.4	2.39
2600	54.6	-2.63	2.41
2650	47.79	-3.21	1.57
2700	46.86	-3.29	1.93
2750	50.79	-2.94	2.27
2800	45.63	-3.41	2.07
2850	34.06	-4.68	0.43
2900	35.94	-4.44	0.58
2950	41.22	-3.85	0.67
3000	35.92	-4.45	1.32
3050	47.07	-3.27	2.53
3100	56.46	-2.48	2.25
3150	53.49	-2.72	2.79
3200	49.24	-3.08	2.42
3250	54.92	-2.6	3.3
3300	44.16	-3.55	2.08
3350	49.17	-3.08	1.1
3400	53.26	-2.74	1.31
3450	40.21	-3.96	-0.34

Maswell Cellular 5G/4G 8X8 MIMO Antenna

Screw Mount IP67 UV stabilized L Plate Mount

AN_Master_Cubic-8C-LP

Appendix : Measured Gain Performances Table

Antenna6 /Cable 6

Passive Test For 400-8000			
Freq (MHz)	Effi (%)	Effi (dB)	Gain (dBi)
3500	43.65	-3.6	0.23
3550	43.16	-3.65	0.28
3600	38.75	-4.12	-0.22
3650	48.64	-3.13	0.49
3700	52.73	-2.78	2.49
3750	41.61	-3.81	1.32
3800	38.24	-4.18	0.02
3850	47.12	-3.27	0.52
3900	55.71	-2.54	2.16
3950	70.85	-1.5	2.78
4000	63.31	-1.99	2.62
4050	67.95	-1.68	3.06
4100	71.45	-1.46	3.01
4150	70.62	-1.51	4.69
4200	62.42	-2.05	5.07
4250	64.88	-1.88	5.14
4300	62.59	-2.03	4.45
4350	49.37	-3.07	2.91
4400	52.47	-2.8	3.1
4450	46.57	-3.32	2.74
4500	36.34	-4.4	2.3
4550	32.93	-4.82	2.17
4600	29.82	-5.25	1.5
4650	30.85	-5.11	0.7
4700	31.36	-5.04	1.49
4750	37.11	-4.31	1.48
4800	42.71	-3.7	1.82
4850	39.83	-4	2

Passive Test For 400-8000			
Freq (MHz)	Effi (%)	Effi (dB)	Gain (dBi)
4900	37.02	-4.32	1.95
4950	34.94	-4.57	2.06
5000	37.44	-4.27	2.98
5050	45.14	-3.45	3.87
5100	42.36	-3.73	3.54
5150	37.09	-4.31	2.55
5200	40.29	-3.95	2.37
5250	47.13	-3.27	3.51
5300	46.5	-3.33	3.65
5350	40.9	-3.88	2.31
5400	40.84	-3.89	1.99
5450	45.1	-3.46	2.54
5500	39.97	-3.98	1.27
5550	37.31	-4.28	1.22
5600	33.48	-4.75	1.07
5650	28.06	-5.52	0.34
5700	22.12	-6.55	-0.46
5750	21.14	-6.75	-0.85
5800	25.79	-5.89	0.1
5850	26.34	-5.79	-0.71
5900	16.13	-7.92	-3.13
5950	16.35	-7.87	-2.96
6000	20.45	-6.89	-2.06
6050	33.56	-4.74	0.37
6100	32.03	-4.94	0.65
6150	30.78	-5.12	0.16
6200	34.13	-4.67	1.5
6250	40.03	-3.98	3.1
6300	40.9	-3.88	3.51
6350	39.83	-4	3.02
6400	44.77	-3.49	2.11
6450	52.81	-2.77	3.22
6500	58.95	-2.3	3.7

Maswell Cellular 5G/4G 8X8 MIMO Antenna Screw Mount IP67 UV stabilized L Plate Mount

AN_Master_Cubic-8C-LP

Appendix : Measured Gain Performances Table Antenna6 /Cable 6

Passive Test For 400-8000			
Freq (MHz)	Effi (%)	Effi (dB)	Gain (dBi)
6550	50.25	-2.99	2.74
6600	45.65	-3.41	1.8
6650	48.78	-3.12	2.2
6700	52.06	-2.84	2.54
6750	44.65	-3.5	1.13
6800	38.76	-4.12	0.83
6850	36.41	-4.39	0.64
6900	30.35	-5.18	-0.49
6950	22.05	-6.57	-1.55
7000	20.45	-6.89	-1.78
7050	22.98	-6.39	-0.68
7100	21.93	-6.59	-1.16
7150	16.67	-7.78	-2.48
7200	12.81	-8.93	-1.97
7250	10.69	-9.71	-1.29
7300	10.94	-9.61	-0.8
7350	11.76	-9.3	-0.43
7400	13.52	-8.69	-0.09
7450	16.21	-7.9	-0.14
7500	16.67	-7.78	-1.09
7550	16.71	-7.77	-1.28
7600	17.16	-7.65	-0.98
7650	20.78	-6.82	0.05
7700	29.49	-5.3	0.93
7750	37.71	-4.24	0.53
7800	38.07	-4.19	0.79
7850	39.66	-4.02	1.24
7900	42.83	-3.68	1.23
7950	47.09	-3.27	1.33
8000	42.32	-3.73	0.38

Maswell Cellular 5G/4G 8X8 MIMO Antenna

Screw Mount IP67 UV stabilized L Plate Mount

AN_Master_Cubic-8C-LP

Appendix : Measured Gain Performances Table

Antenna7 /Cable 7

Passive Test For 400-8000			
Freq (MHz)	Effi (%)	Effi (dB)	Gain (dBi)
700	4.4	-13.56	-8
750	10.34	-9.86	-5.21
800	18.45	-7.34	-3.33
850	25.58	-5.92	-2.11
900	31.37	-5.03	-0.9
950	37.73	-4.23	0.01
1000	45.35	-3.43	1.48
1050	31.33	-5.04	-0.68
1100	27.55	-5.6	-0.04
1150	35.06	-4.55	0.4
1200	42.59	-3.71	-0.38
1250	41.66	-3.8	0.78
1300	48.14	-3.17	2.4
1350	67.53	-1.71	3.2
1400	61.37	-2.12	2.11
1450	51.44	-2.89	3.02
1500	34.33	-4.64	0.08
1500	34.33	-4.64	0.08
1550	41.93	-3.78	2
1600	46.11	-3.36	1.82
1650	46.6	-3.32	2.86
1700	39.94	-3.99	3.77
1750	30.92	-5.1	1.25
1800	28.29	-5.48	0.64
1850	33.79	-4.71	0.47
1900	38	-4.2	0.42
1950	45.41	-3.43	0.81

Passive Test For 400-8000			
Freq (MHz)	Effi (%)	Effi (dB)	Gain (dBi)
2000	42.45	-3.72	1.23
2050	31.86	-4.97	0.78
2100	39.54	-4.03	1.47
2150	35.21	-4.53	1.49
2200	33.17	-4.79	-0.61
2250	25.29	-5.97	-0.86
2300	38.87	-4.1	1.77
2350	49.59	-3.05	2.84
2400	50.56	-2.96	2
2450	46.87	-3.29	0.53
2500	47.24	-3.26	0.62
2550	57.21	-2.43	2.76
2600	60.27	-2.2	3.81
2650	51.92	-2.85	2.26
2700	47.41	-3.24	3.16
2750	48.6	-3.13	3.35
2800	44.42	-3.52	2.92
2850	36.83	-4.34	2.23
2900	40.57	-3.92	1.49
2950	33.78	-4.71	0.63
3000	19.99	-6.99	-2.26
3050	40.9	-3.88	1.16
3100	52.97	-2.76	2.24
3150	48.07	-3.18	1.59
3200	37.85	-4.22	0.48
3250	40.25	-3.95	1
3300	36.71	-4.35	-0.23
3350	48.08	-3.18	1.37
3400	50.07	-3	1.22
3450	38.08	-4.19	0.11
3500	45.07	-3.46	1.13

Maswell Cellular 5G/4G 8X8 MIMO Antenna

Screw Mount IP67 UV stabilized L Plate Mount

AN_Master_Cubic-8C-LP

Appendix : Measured Gain Performances Table

Antenna7 /Cable 7

Freq (MHz)	Effi (%)	Effi (dB)	Gain (dBi)
3550	46.94	-3.28	0.77
3600	47.84	-3.2	1.54
3650	48.19	-3.17	1.91
3700	44.43	-3.52	1.98
3750	42.12	-3.75	2.57
3800	48.81	-3.11	3.2
3850	48.99	-3.1	3.35
3900	50.47	-2.97	3.58
3950	72.49	-1.4	4.88
4000	69.25	-1.6	5.33
4050	70.02	-1.55	5.5
4100	72.97	-1.37	5.39
4150	65.11	-1.86	4.09
4200	51.71	-2.86	3.41
4250	58.72	-2.31	4.01
4300	64.91	-1.88	2.89
4350	49.34	-3.07	1.23
4400	49.01	-3.1	3.04
4450	49.62	-3.04	3.07
4500	46.92	-3.29	2.49
4500	46.92	-3.29	2.49
4550	44.24	-3.54	0.69
4600	37.77	-4.23	0.21
4650	37.82	-4.22	0.23
4700	33.71	-4.72	0.78
4750	29.59	-5.29	0.91
4800	31.5	-5.02	0.97
4850	32.48	-4.88	1.11
4900	36.34	-4.4	1.22
4950	37	-4.32	0.94
5000	36.56	-4.37	1.38
5050	43.39	-3.63	2.82

Passive Test For 400-8000			
Freq (MHz)	Effi (%)	Effi (dB)	Gain (dBi)
5100	46.36	-3.34	3.52
5150	46.86	-3.29	3.23
5200	46.5	-3.33	2.95
5250	49.71	-3.04	2.44
5300	51.47	-2.88	2.67
5350	46.89	-3.29	2.11
5400	43.69	-3.6	1.72
5450	46.13	-3.36	1.88
5500	43.87	-3.58	2.02
5550	44.44	-3.52	2.04
5600	38.87	-4.1	1.47
5650	35.56	-4.49	0.82
5700	37.57	-4.25	1.64
5750	46	-3.37	2.41
5800	44.4	-3.53	1.96
5850	36.7	-4.35	1.01
5900	31.13	-5.07	0.44
5950	41.25	-3.85	1.74
6000	44.49	-3.52	2.56
6050	46.12	-3.36	2.88
6100	38.5	-4.15	1.47
6150	38.88	-4.1	1.69
6200	37.04	-4.31	1.81
6250	34.71	-4.6	0.95
6300	41.62	-3.81	0.89
6350	56.63	-2.47	2.1
6400	54.62	-2.63	1.47
6450	44.17	-3.55	1.19
6500	45.7	-3.4	1.02
6550	51.18	-2.91	1.8
6600	50.78	-2.94	1.98
6650	42.92	-3.67	0.52
6700	38.8	-4.11	0.03

Maswell Cellular 5G/4G 8X8 MIMO Antenna Screw Mount IP67 UV stabilized L Plate Mount

AN_Master_Cubic-8C-LP

Appendix : Measured Gain Performances Table Antenna7 /Cable 7

Passive Test For 400-8000			
Freq (MHz)	Effi (%)	Effi (dB)	Gain (dBi)
6750	33.99	-4.69	-0.01
6800	26.62	-5.75	-0.77
6850	26.66	-5.74	-1.39
6900	30.89	-5.1	-0.65
6950	24.29	-6.15	-2.35
7000	15.96	-7.97	-3.44
7050	14.51	-8.38	-3.23
7100	18.37	-7.36	-2.85
7150	22.62	-6.46	-1.73
7200	17.76	-7.51	-2.8
7250	14.61	-8.35	-3.74
7300	16.25	-7.89	-3.36
7350	17.1	-7.67	-2.49
7400	17.07	-7.68	-2.53
7450	19.18	-7.17	-2.05
7500	25.27	-5.97	-0.13
7550	29.59	-5.29	0.51
7600	21.26	-6.72	-0.66
7650	16.63	-7.79	-2.81
7700	20.38	-6.91	-1.74
7750	30.11	-5.21	0.61
7800	31.63	-5	0.88
7850	28.71	-5.42	-1.1
7900	29.23	-5.34	-1.52
7950	33.05	-4.81	-0.42
8000	30.48	-5.16	-0.41

Maswell Cellular 5G/4G 8X8 MIMO Antenna Screw Mount IP67 UV stabilized L Plate Mount

AN_Master_Cubic-8C-LP

Appendix : Measured Gain Performances Table Antenna8 /Cable 8

Passive Test For 400-8000			
Freq (MHz)	Effi (%)	Effi (dB)	Gain (dBi)
700	9.19	-10.37	-5.64
750	15.53	-8.09	-3.91
800	31.34	-5.04	-2.27
850	30.64	-5.14	-0.92
900	39.71	-4.01	-0.51
950	42.31	-3.74	0.84
1000	43.18	-3.65	1.25
1050	35.56	-4.49	0.03
1100	29.74	-5.27	-1.34
1150	34.73	-4.59	-0.86
1200	32.92	-4.83	0.39
1250	36.34	-4.4	0.63
1300	43.74	-3.59	1.49
1350	47	-3.28	1.55
1400	41.89	-3.78	1.53
1450	36.08	-4.43	0.3
1500	28.44	-5.46	0.73
1550	37.39	-4.27	1.79
1600	43.33	-3.63	0.43
1650	58.22	-2.35	2.28
1700	60.19	-2.2	2.28
1750	40.06	-3.97	0.75
1800	43.35	-3.63	2.17
1850	36.25	-4.41	2.2
1900	36.57	-4.37	1.9
1950	37.06	-4.31	1.49
2000	34.49	-4.62	2.35
2050	42.32	-3.73	3.13
2100	63.48	-1.97	4.42

Passive Test For 400-8000			
Freq (MHz)	Effi (%)	Effi (dB)	Gain (dBi)
2150	63.53	-1.97	4.42
2200	60.26	-2.2	3.46
2250	59.26	-2.27	3.53
2300	62.83	-2.02	3.36
2350	57.69	-2.39	3.11
2400	43.76	-3.59	1.45
2450	39.68	-4.01	1.25
2500	51.39	-2.89	1.93
2550	57.09	-2.43	2.46
2600	55.39	-2.57	2.34
2650	48.14	-3.17	1.41
2700	41.12	-3.86	0.9
2750	45.04	-3.46	1.06
2800	41.56	-3.81	1.85
2850	33.77	-4.71	1.05
2900	37.82	-4.22	1.23
2950	37.73	-4.23	1.47
3000	24.01	-6.2	0.34
3050	40.01	-3.98	1.64
3100	53.1	-2.75	2.88
3150	45.86	-3.39	2.08
3200	36.96	-4.32	1.08
3250	39.52	-4.03	2.32
3300	39.15	-4.07	2.03
3350	49.08	-3.09	2.65
3400	42.33	-3.73	1.68
3450	33.48	-4.75	0.14
3500	43.46	-3.62	1.54
3550	45.93	-3.38	2.94
3600	48.21	-3.17	3.39
3650	50.45	-2.97	2.5

Maswell Cellular 5G/4G 8X8 MIMO Antenna Screw Mount IP67 UV stabilized L Plate Mount

AN_Master_Cubic-8C-LP

Appendix : Measured Gain Performances Table Antenna8 /Cable 8

Passive Test For 400-8000			
Freq (MHz)	Effi (%)	Effi (dB)	Gain (dBi)
3700	41.95	-3.77	3.29
3750	40.75	-3.9	3.46
3800	44.07	-3.56	3.25
3850	42.16	-3.75	3.03
3900	46.64	-3.31	2.85
3950	68.34	-1.65	4.55
4000	67.02	-1.74	4.78
4050	72.16	-1.42	4.49
4100	78.93	-1.03	4.94
4150	75.72	-1.21	4.73
4200	58.53	-2.33	3.51
4250	64.44	-1.91	3.2
4300	67.34	-1.72	3.41
4350	48.78	-3.12	2.34
4400	47.6	-3.22	1.7
4450	48.43	-3.15	1.87
4500	46.54	-3.32	1.64
4550	40	-3.98	1.94
4600	34.75	-4.59	1.56
4650	35.53	-4.49	0.96
4700	32.65	-4.86	1
4750	31.28	-5.05	0.86
4800	30.92	-5.1	0.43
4850	31.34	-5.04	0.31
4900	31.41	-5.03	1.01
4950	28.17	-5.5	0.96
5000	29.41	-5.31	1.31
5050	37.89	-4.21	2.24
5100	38.92	-4.1	2.44
5150	36.73	-4.35	2.12

Passive Test For 400-8000			
Freq (MHz)	Effi (%)	Effi (dB)	Gain (dBi)
5200	38.91	-4.1	1.62
5250	45.34	-3.43	1.78
5300	44.38	-3.53	1.19
5350	40.03	-3.98	0.81
5400	41.11	-3.86	0.85
5450	44.48	-3.52	0.31
5500	42.05	-3.76	1.1
5550	43.67	-3.6	1.74
5600	37.79	-4.23	1.02
5650	31.34	-5.04	-0.52
5700	31.1	-5.07	-0.7
5750	37.25	-4.29	0.02
5800	32.89	-4.83	0.94
5850	25.2	-5.99	-0.26
5900	24.72	-6.07	-0.54
5950	37.68	-4.24	1.04
6000	43.78	-3.59	1.76
6050	42.22	-3.75	2.07
6100	35.15	-4.54	0.64
6150	38.69	-4.12	1.63
6200	38.88	-4.1	2.44
6250	33.34	-4.77	1.23
6300	36.59	-4.37	1.36
6350	47.57	-3.23	1.94
6400	47.4	-3.24	1.57
6450	38.06	-4.2	0.82
6500	39.64	-4.02	1.4
6550	48.93	-3.1	1.73
6600	48.85	-3.11	1.7
6650	39.12	-4.08	1.51

Maswell Cellular 5G/4G 8X8 MIMO Antenna Screw Mount IP67 UV stabilized L Plate Mount

AN_Master_Cubic-8C-LP

Appendix : Measured Gain Performances Table Antenna8 /Cable 8

Passive Test For 400-8000			
Freq (MHz)	Effi (%)	Effi (dB)	Gain (dBi)
6700	36.87	-4.33	1.73
6750	36.1	-4.43	1.71
6800	30.45	-5.16	0.91
6850	30.21	-5.2	0.52
6900	31.61	-5	0.94
6950	25.64	-5.91	0.02
7000	19.23	-7.16	-0.94
7050	17.06	-7.68	-1.46
7100	18.61	-7.3	-0.63
7150	19.28	-7.15	-1.25
7200	14.87	-8.28	-3.15
7250	11.75	-9.3	-4.23
7300	11.57	-9.37	-3.59
7350	12.69	-8.97	-1.98
7400	14.1	-8.51	-2.57
7450	17.6	-7.55	-1.88
7500	20.17	-6.95	-0.88
7550	20.09	-6.97	-0.75
7600	18.87	-7.24	-0.71
7650	21.78	-6.62	-0.64
7700	32.47	-4.89	0.6
7750	41.2	-3.85	1.66
7800	41.53	-3.82	1.41
7850	39.37	-4.05	1.1
7900	42.12	-3.75	1.96
7950	43.96	-3.57	2.87
8000	39.77	-4	2.58

Maswell Cellular 5G/4G 8X8 MIMO Antenna Screw Mount IP67 UV stabilized L Plate Mount

AN_Master_Cubic-8C-LP

Radiation Pattern Antenna1

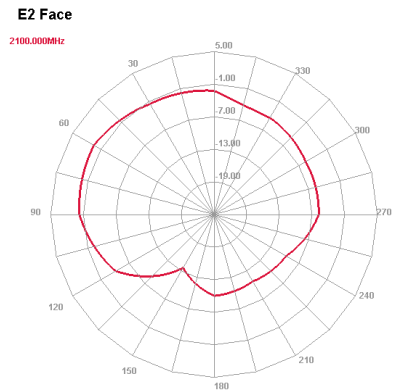
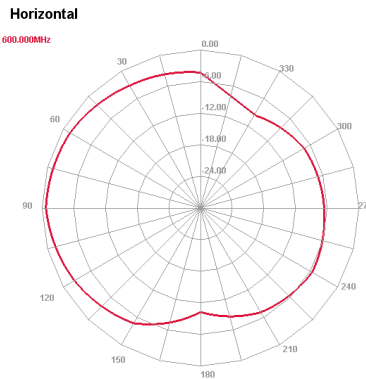
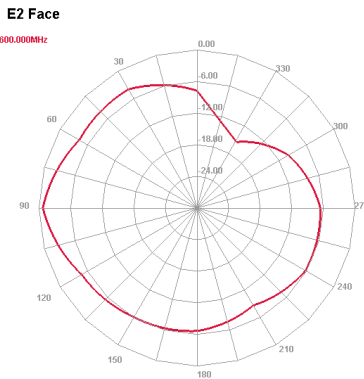

600 MHz E plane

600 MHz H plane

2100 MHz E plane

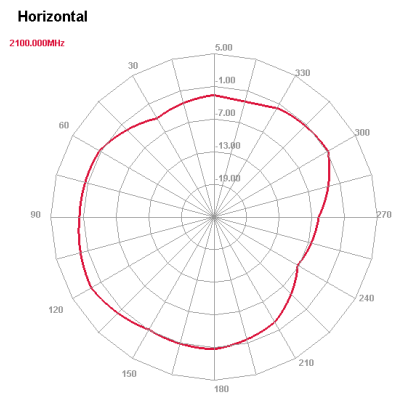
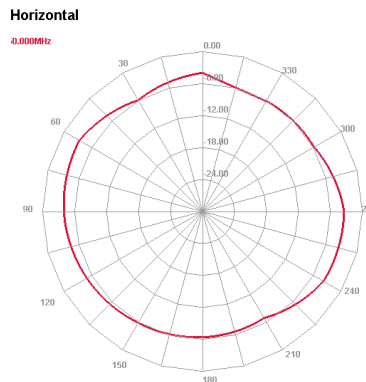
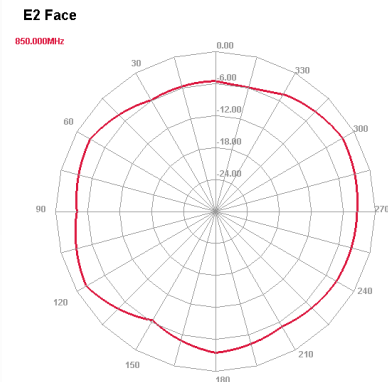

850 MHz E2 plane

850 MHz H plane

2100 MHz H plane

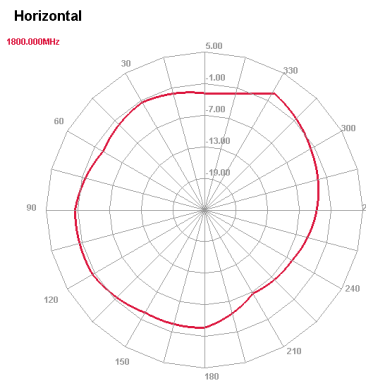
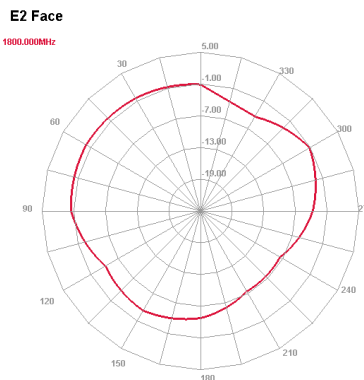

1800 MHz E plane

1800 MHz H plane

Maswell Cellular 5G/4G 8X8 MIMO Antenna Screw Mount IP67 UV stabilized L Plate Mount

AN_Master_Cubic-8C-LP

Radiation Pattern Antenna1

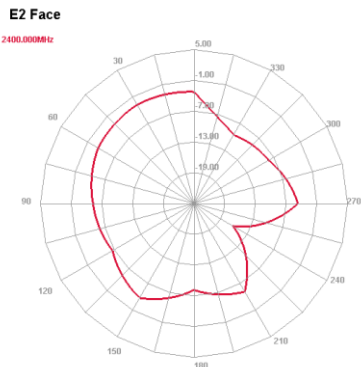

2400 MHz E plane

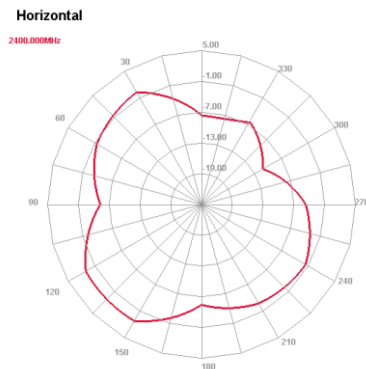

2400 MHz H plane

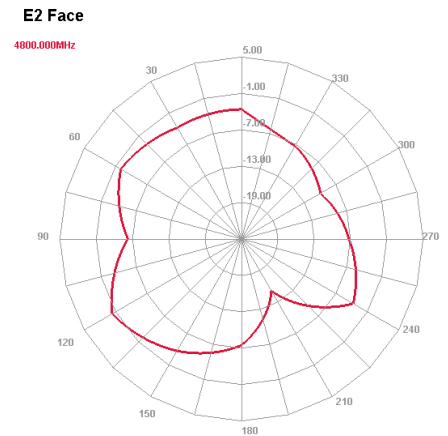

4800 MHz E plane

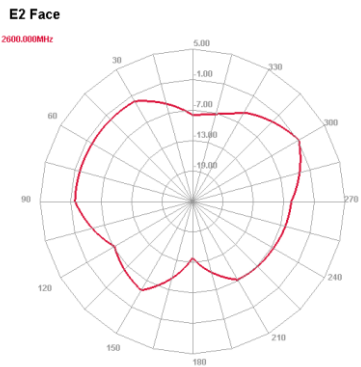

2600 MHz E plane

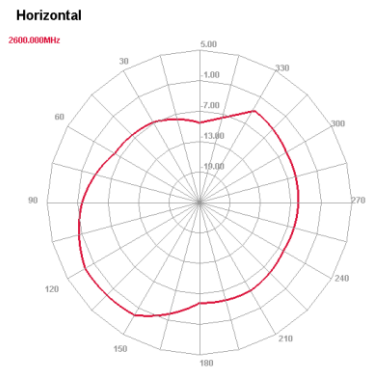

2600 MHz H plane

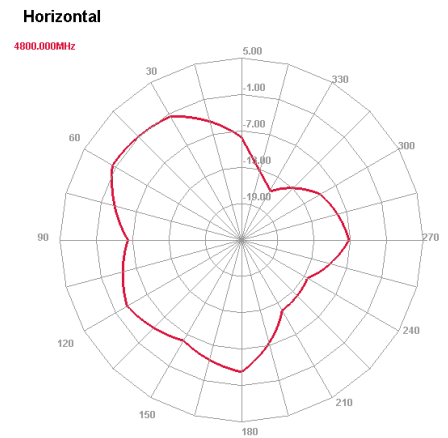

4800 MHz H plane

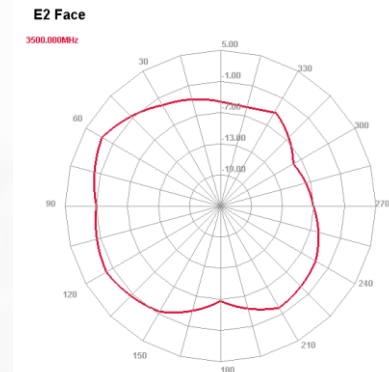

3500 MHz E plane

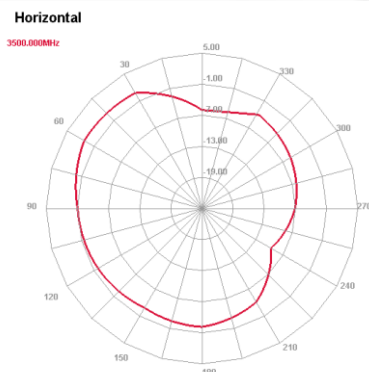

3500 MHz H plane

Maswell Cellular 5G/4G 8X8 MIMO Antenna Screw Mount IP67 UV stabilized L Plate Mount

AN_Master_Cubic-8C-LP

Radiation Pattern Antenna1

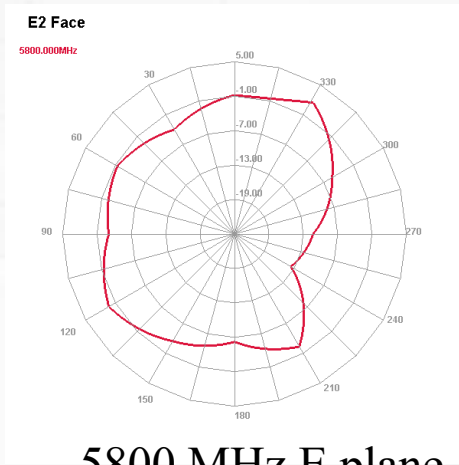

5800 MHz E plane

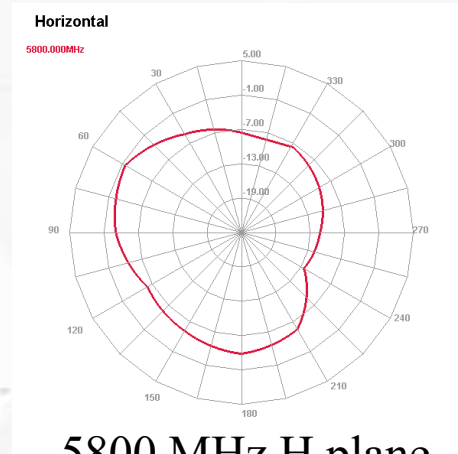

5800 MHz H plane

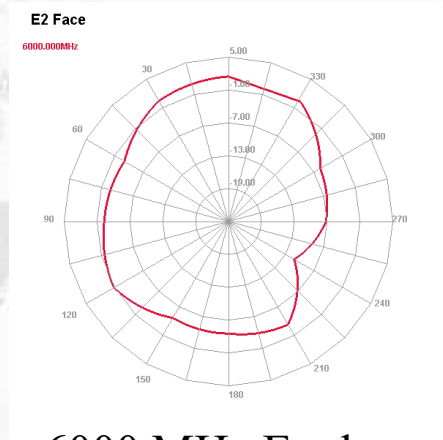

6000 MHz E plane

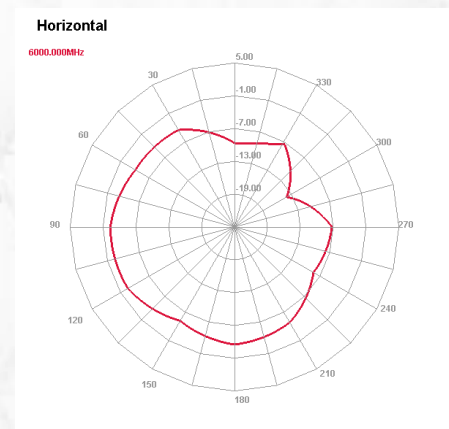

6000 MHz H plane

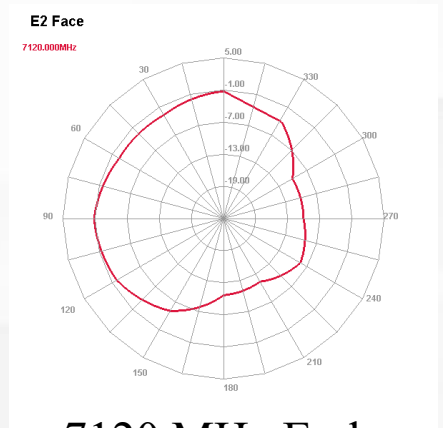

7120 MHz E plane

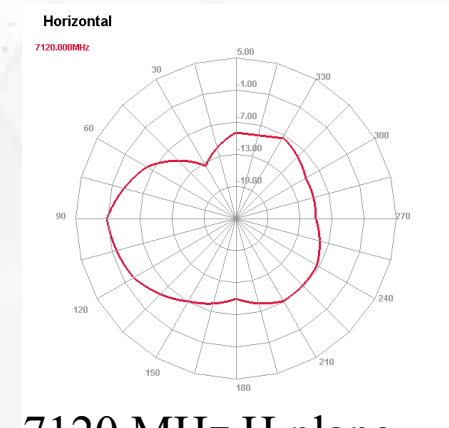

7120 MHz H plane

Maswell Cellular 5G/4G 8X8 MIMO Antenna Screw Mount IP67 UV stabilized L Plate Mount

AN_Master_Cubic-8C-LP

Radiation Pattern Antenna2

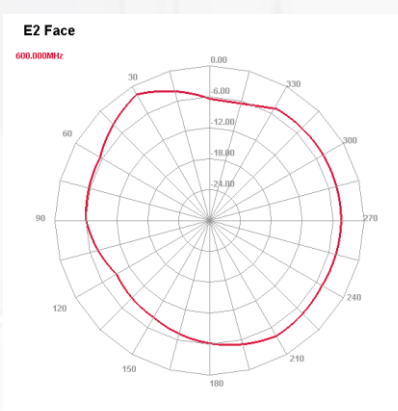

600 MHz E plane

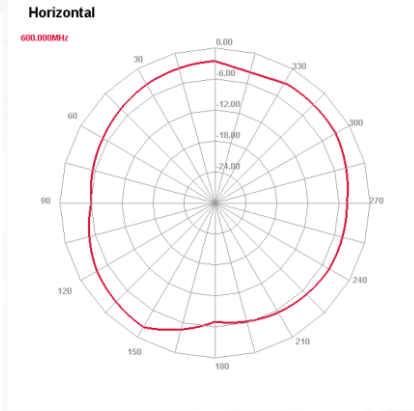

600 MHz H plane

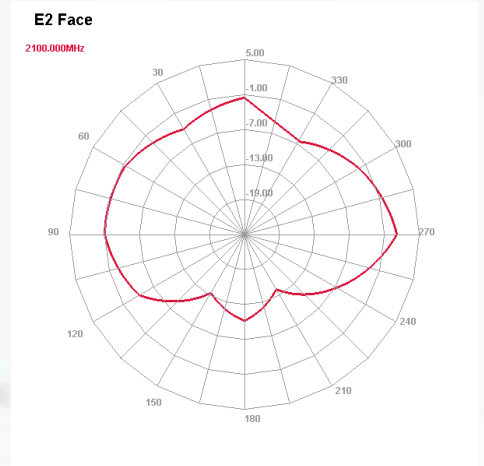

2100 MHz E plane

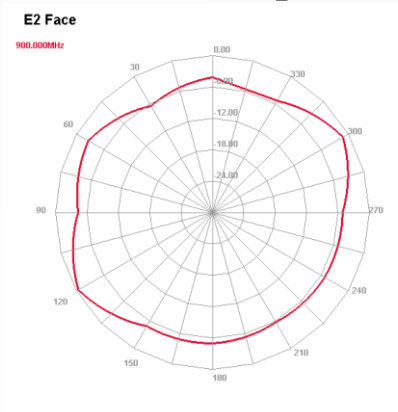

850 MHz E2 plane

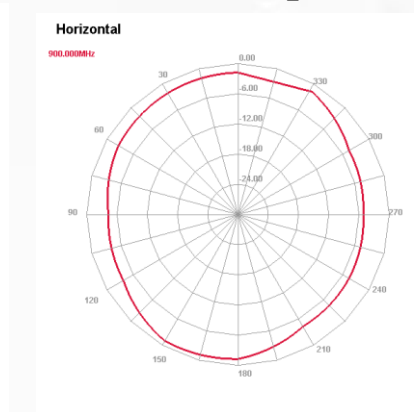

850 MHz H plane

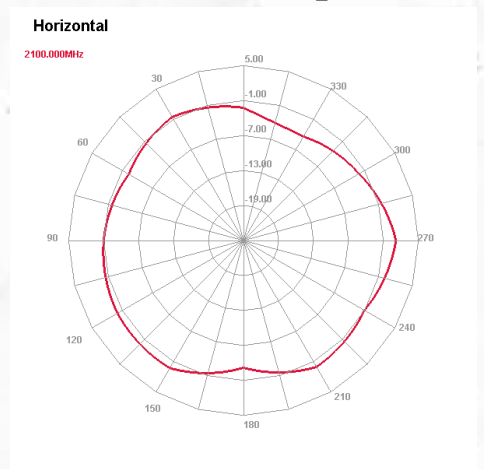

2100 MHz H plane

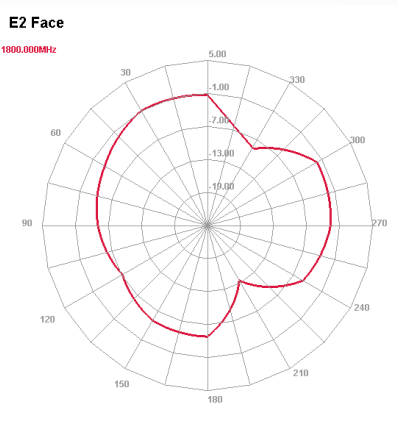

1800 MHz E plane

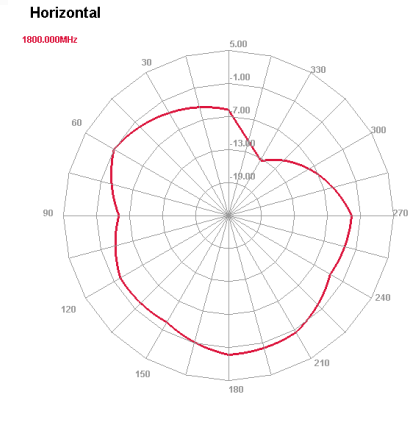

1800 MHz H plane

Maswell Cellular 5G/4G 8X8 MIMO Antenna Screw Mount IP67 UV stabilized L Plate Mount

AN_Master_Cubic-8C-LP

Radiation Pattern Antenna2

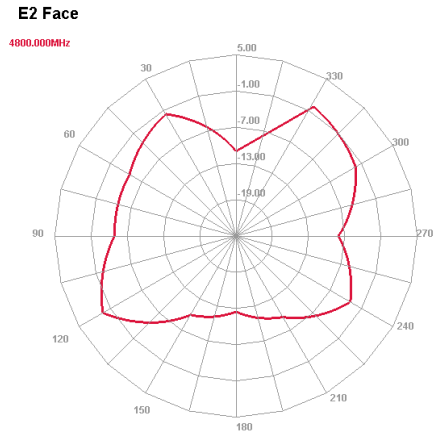
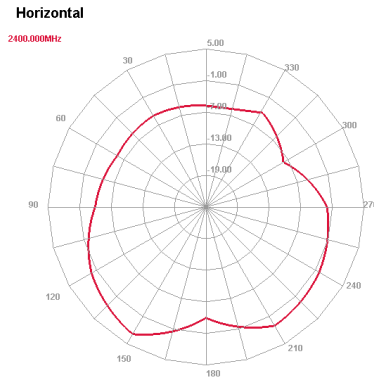
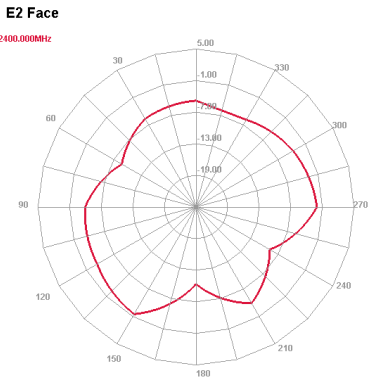

2400 MHz E plane

2400 MHz H plane

4800 MHz E plane

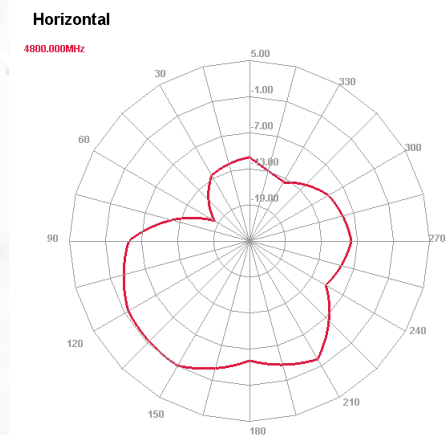
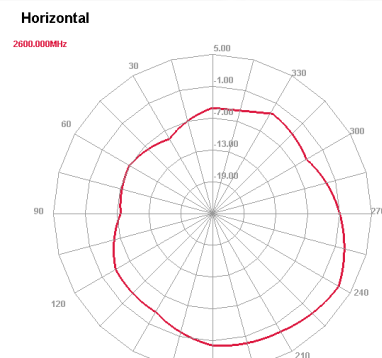
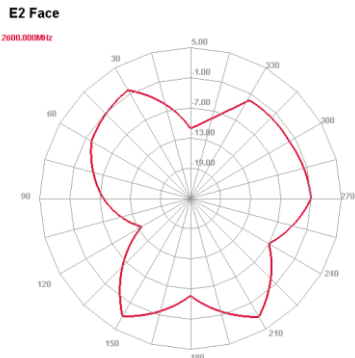

2600 MHz E plane

2600 MHz H plane

4800 MHz H plane

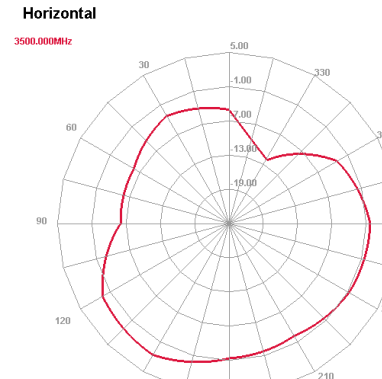
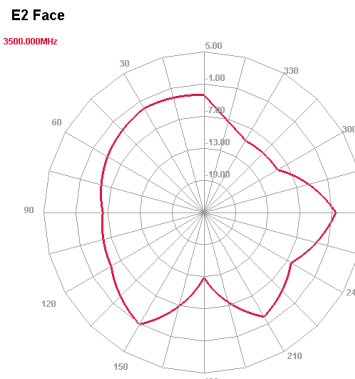

3500 MHz E plane

3500 MHz H plane

Maswell Cellular 5G/4G 8X8 MIMO Antenna Screw Mount IP67 UV stabilized L Plate Mount

AN_Master_Cubic-8C-LP

Radiation Pattern Antenna2

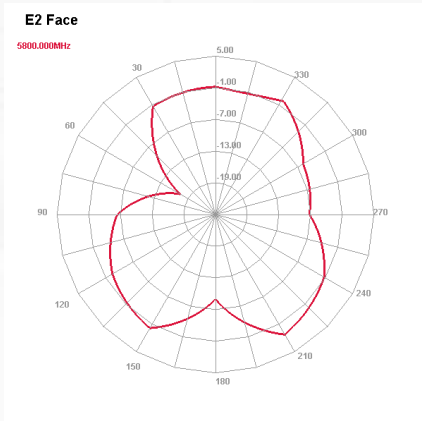

5800 MHz E plane

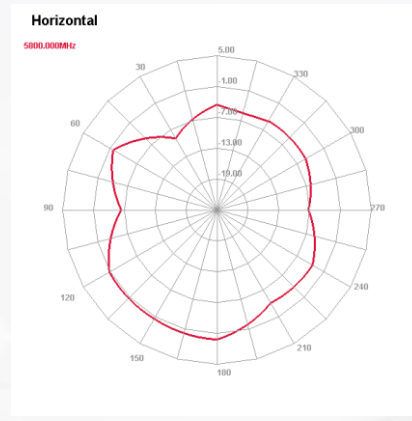

5800 MHz H plane

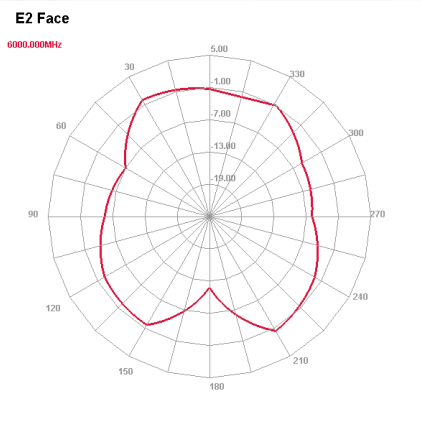

6000 MHz E plane

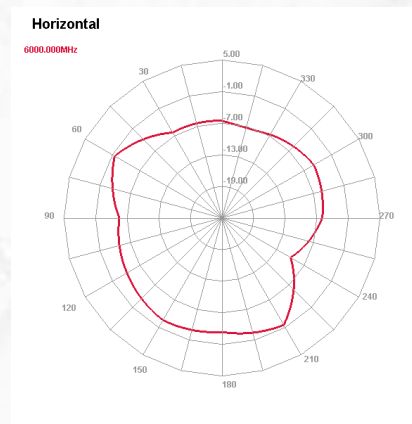

6000 MHz H plane

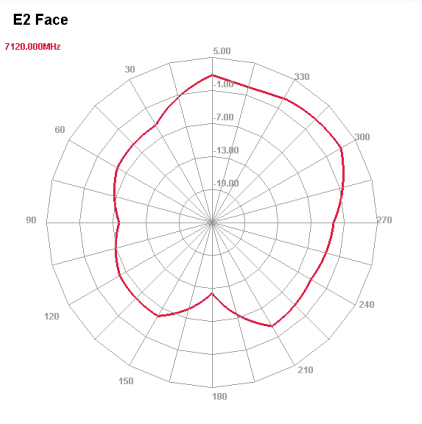

7120 MHz E plane

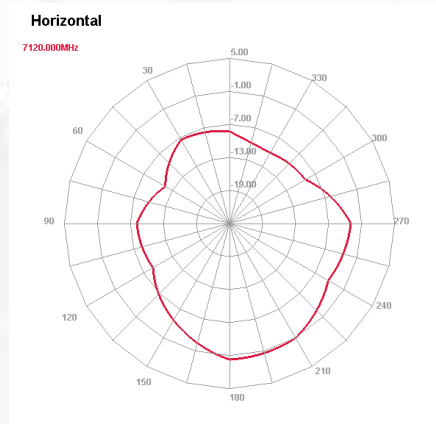

7120 MHz H plane

Maswell Cellular 5G/4G 8X8 MIMO Antenna Screw Mount IP67 UV stabilized L Plate Mount

AN_Master_Cubic-8C-LP

Radiation Pattern Antenna3

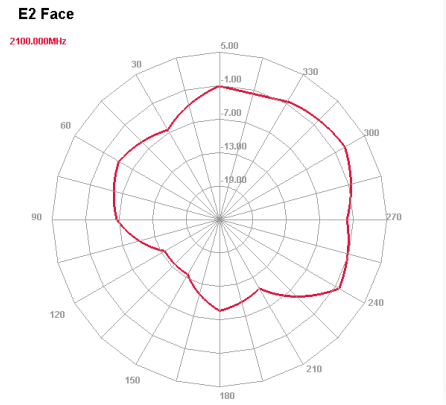
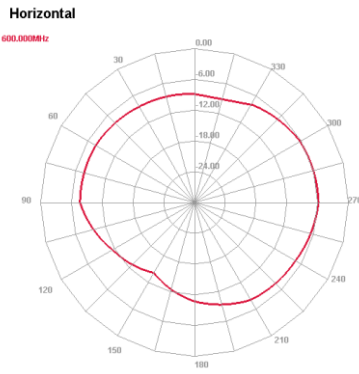
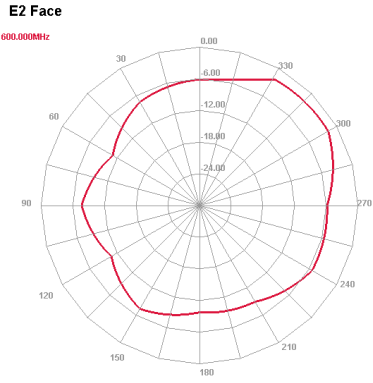

600 MHz E plane

600 MHz H plane

2100 MHz E plane

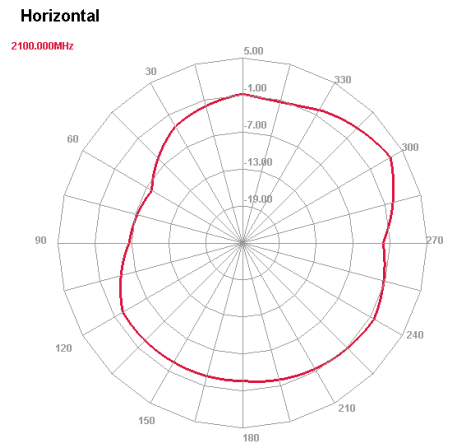
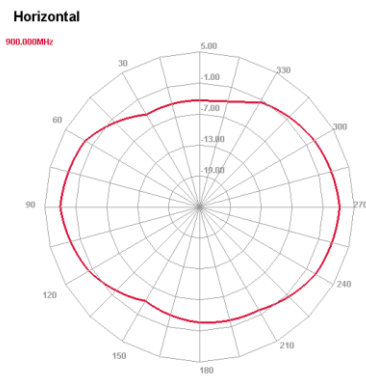
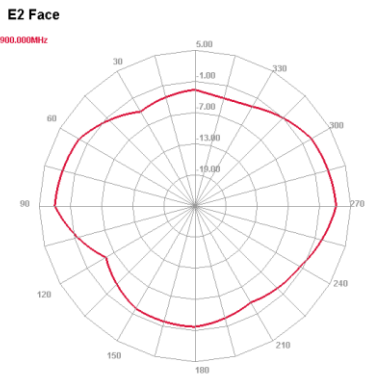

900 MHz E plane

900 MHz H plane

2100 MHz H plane

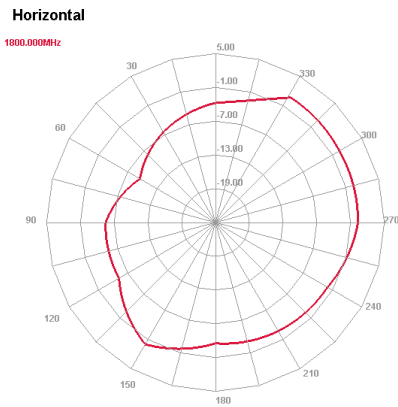
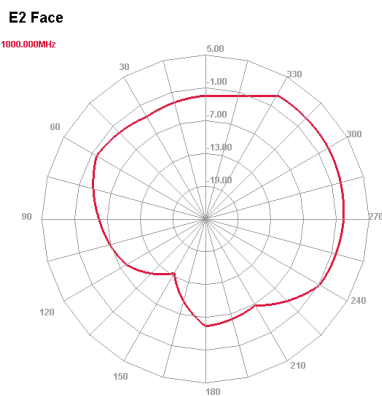

1800 MHz E plane

1800 MHz H plane

Maswell Cellular 5G/4G 8X8 MIMO Antenna Screw Mount IP67 UV stabilized L Plate Mount

AN_Master_Cubic-8C-LP

Radiation Pattern Antenna3

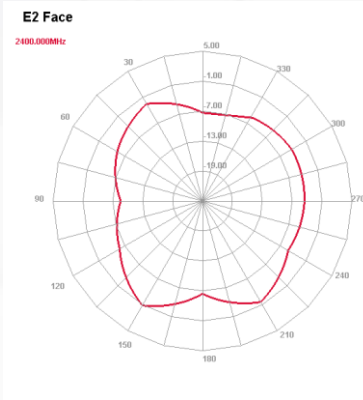

2400 MHz E plane

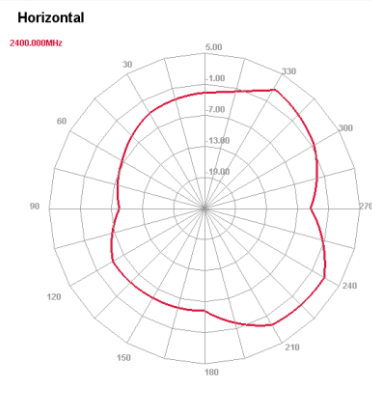

2400 MHz H plane

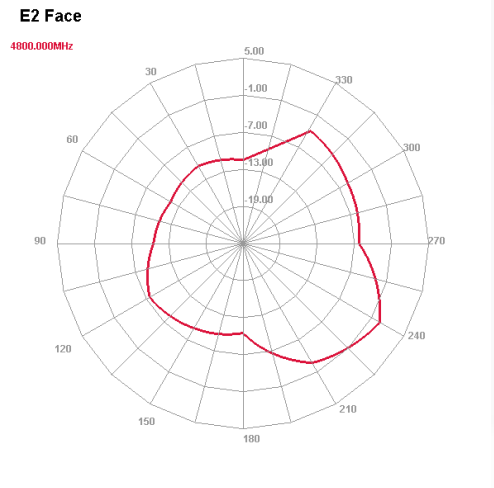

4800 MHz E plane

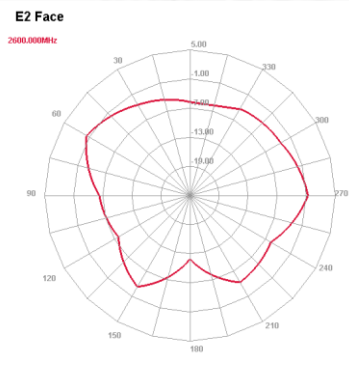

2600 MHz E plane

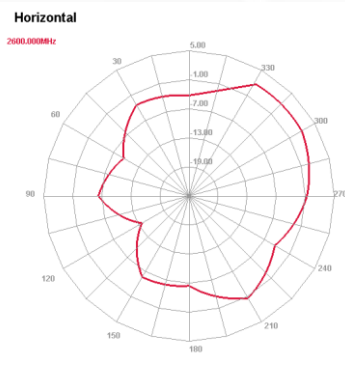

2600 MHz H plane

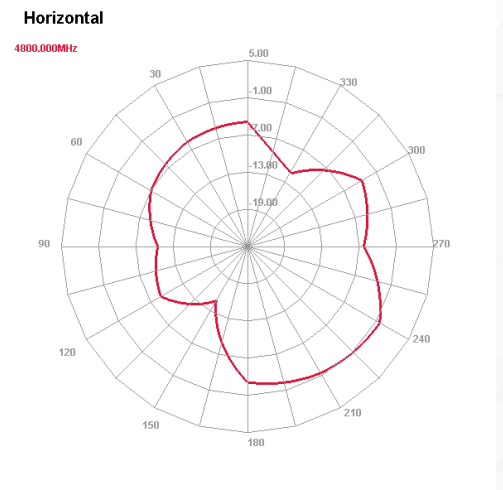

4800 MHz H plane

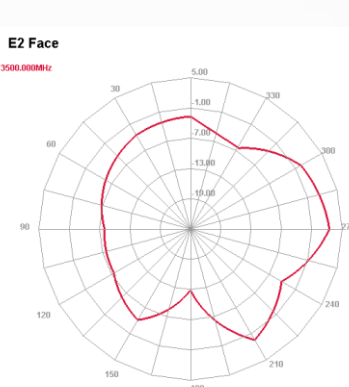

3500 MHz E plane

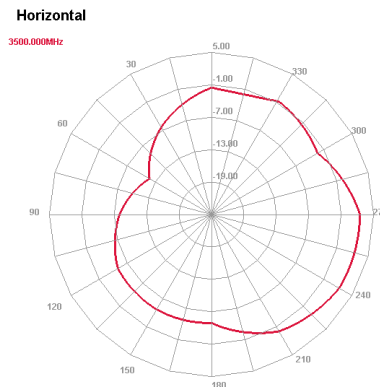

3500 MHz H plane

Maswell Cellular 5G/4G 8X8 MIMO Antenna Screw Mount IP67 UV stabilized L Plate Mount

AN_Master_Cubic-8C-LP

Radiation Pattern Antenna3

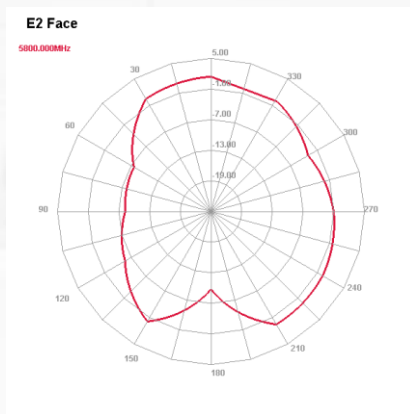

5800 MHz E plane

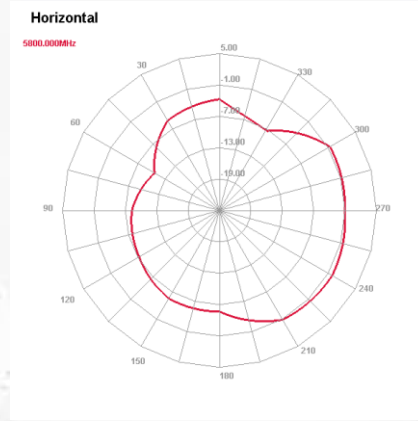

5800 MHz H plane

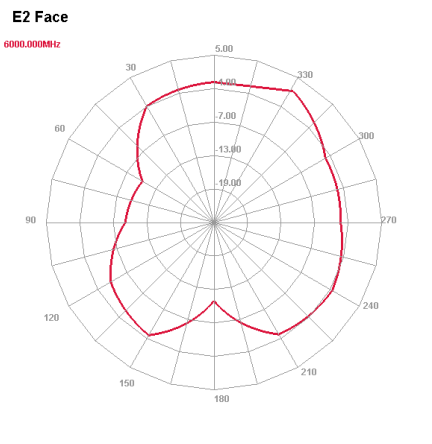

6000 MHz E plane

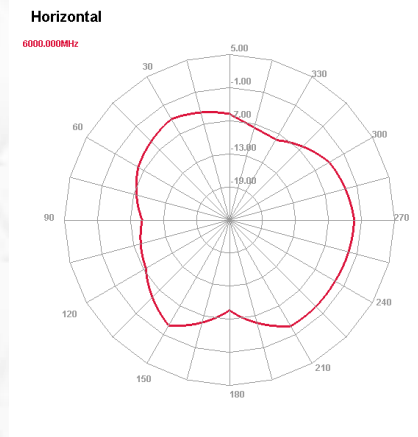

6000 MHz H plane

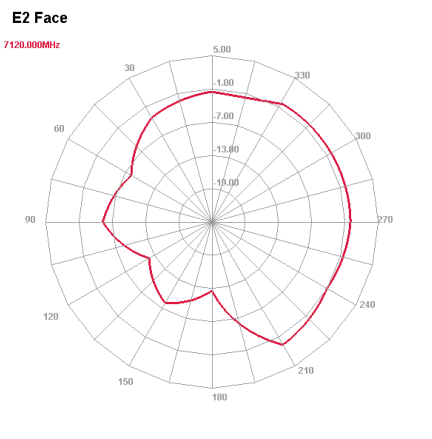

7120 MHz E plane

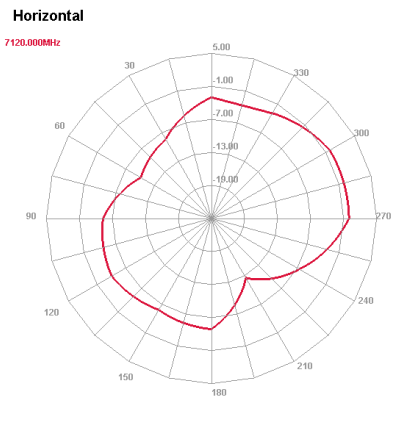

7120 MHz H plane

Maswell Cellular 5G/4G 8X8 MIMO Antenna Screw Mount IP67 UV stabilized L Plate Mount

AN_Master_Cubic-8C-LP

Radiation Pattern Antenna4

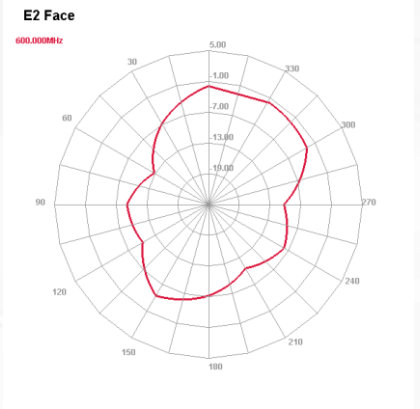

600 MHz E plane

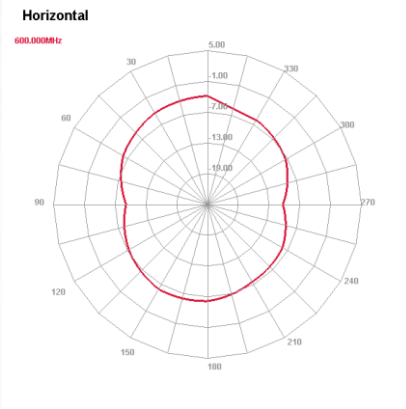

600 MHz H plane

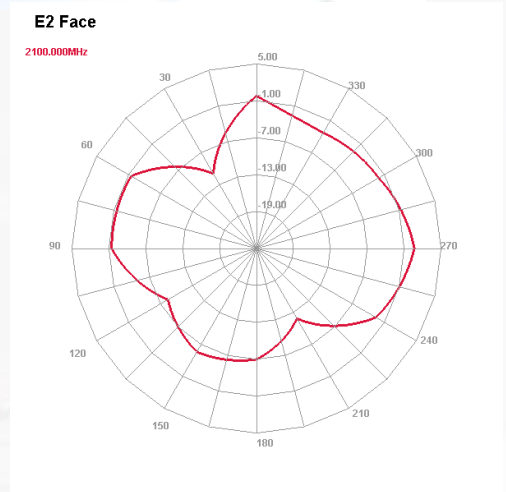

2100 MHz E plane

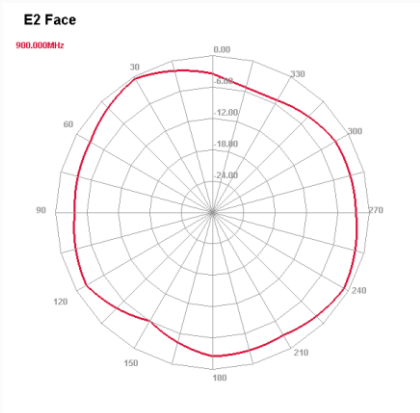

900 MHz E plane

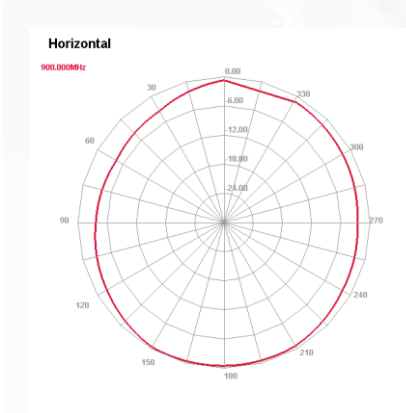

900 MHz H plane

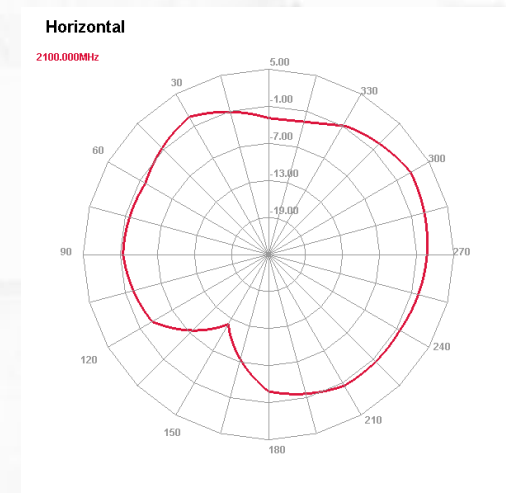

2100 MHz H plane

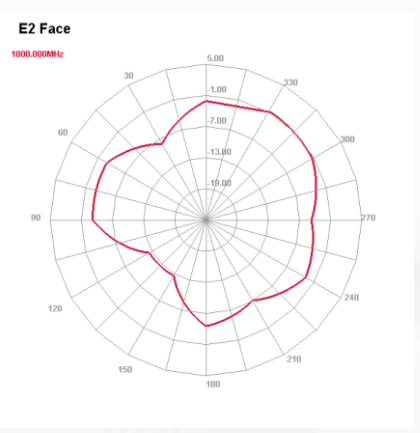

1800 MHz E plane

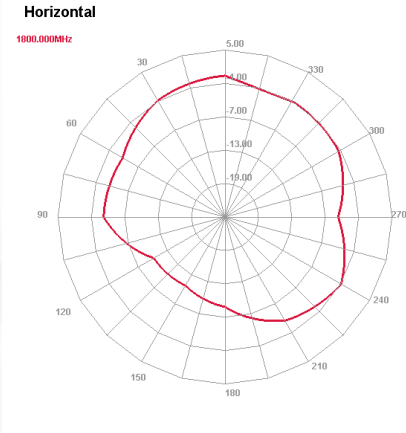

1800 MHz H plane

Maswell Cellular 5G/4G 8X8 MIMO Antenna Screw Mount IP67 UV stabilized L Plate Mount

AN_Master_Cubic-8C-LP

Radiation Pattern Antenna4

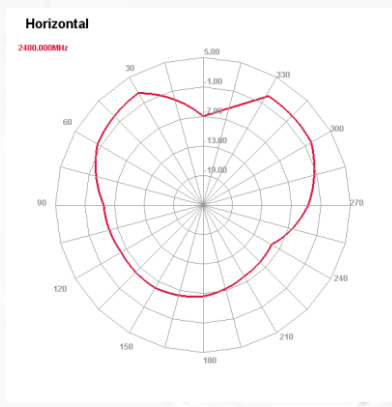
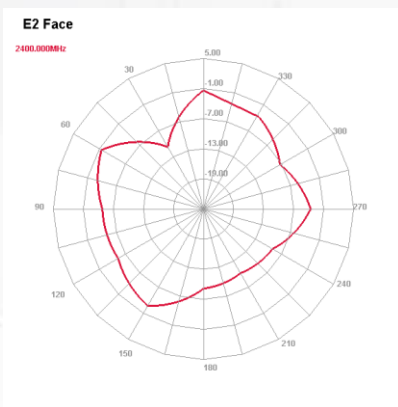

2400 MHz E plane

2400 MHz H plane

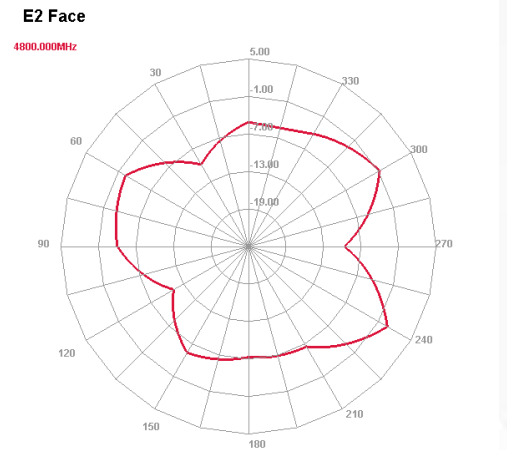

4800 MHz E plane

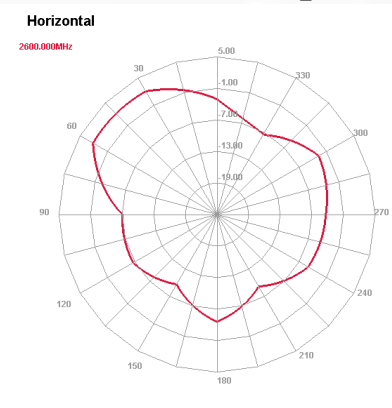
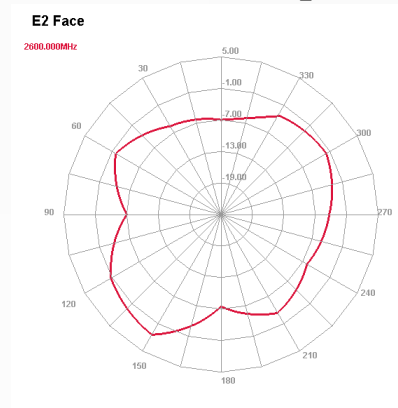

2600 MHz E plane

2600 MHz H plane

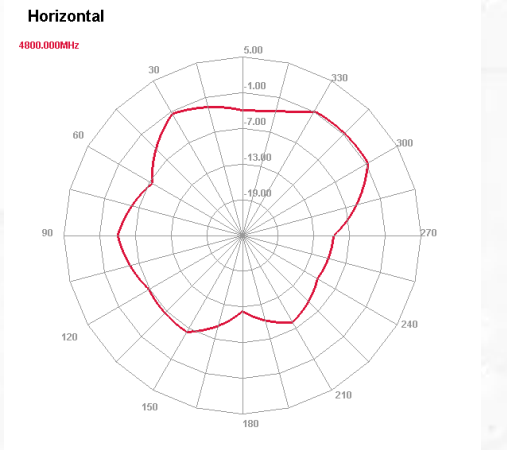

4800 MHz H plane

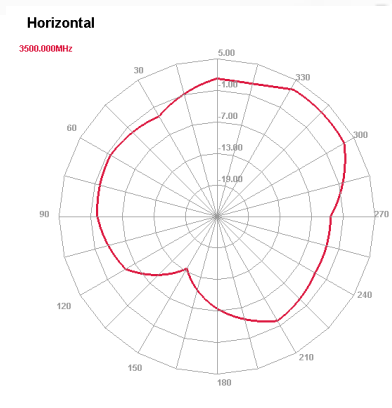
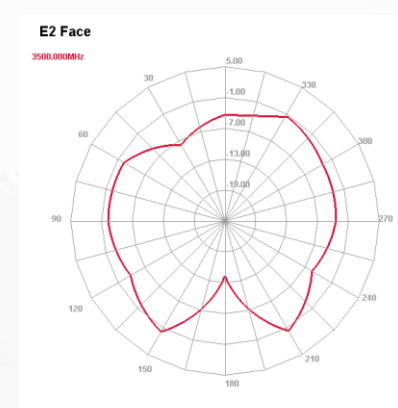

3500 MHz E plane

3500 MHz H plane

Maswell Cellular 5G/4G 8X8 MIMO Antenna Screw Mount IP67 UV stabilized L Plate Mount

AN_Master_Cubic-8C-LP

Radiation Pattern Antenna4

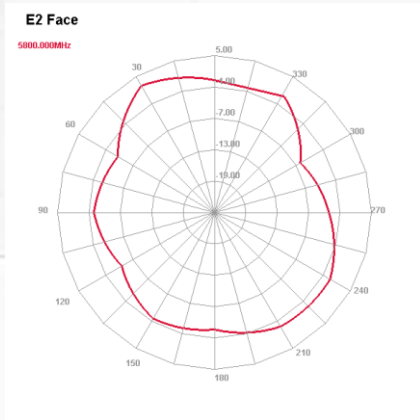

5800 MHz E plane

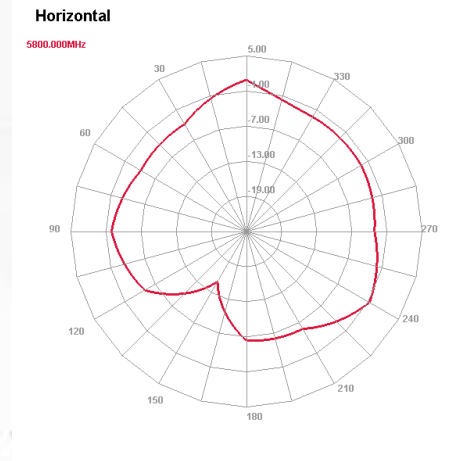

5800 MHz H plane

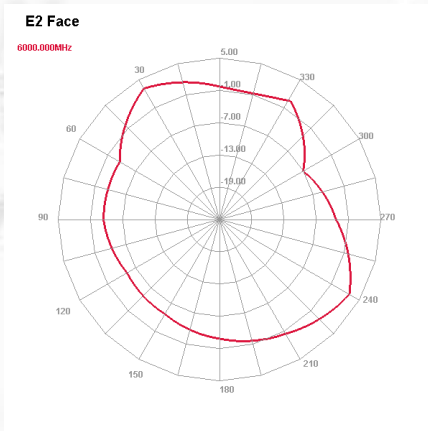

6000 MHz E plane

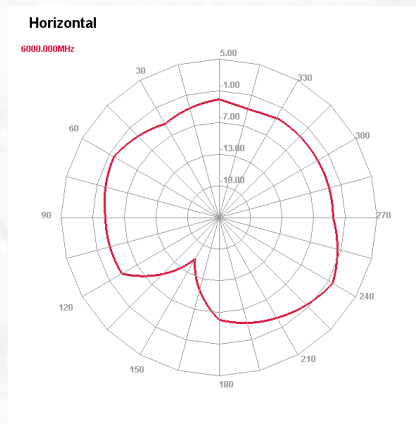

6000 MHz H plane

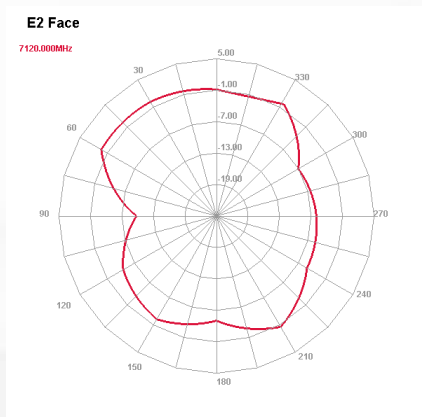

7120 MHz E plane

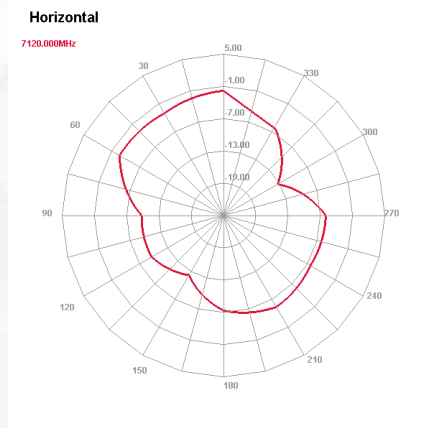

7120 MHz H plane

Maswell Cellular 5G/4G 8X8 MIMO Antenna Screw Mount IP67 UV stabilized L Plate Mount

AN_Master_Cubic-8C-LP

Radiation Pattern Antenna5

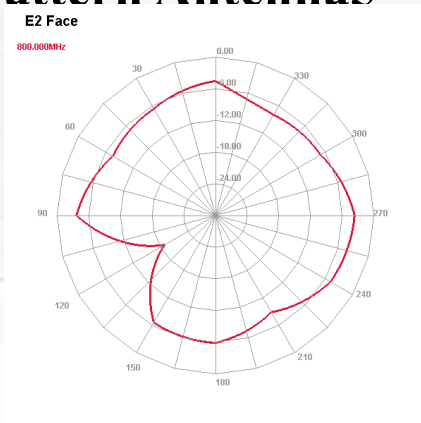

800 MHz E plane

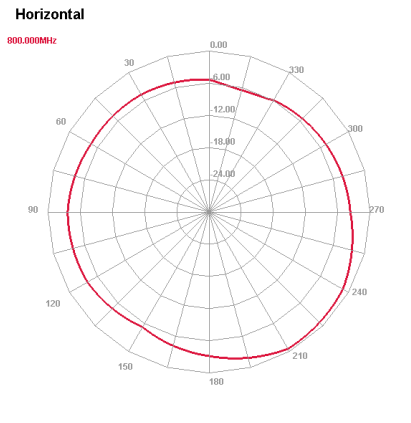

800 MHz H plane

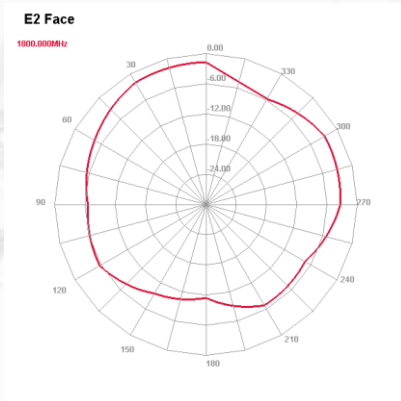

1800 MHz E plane

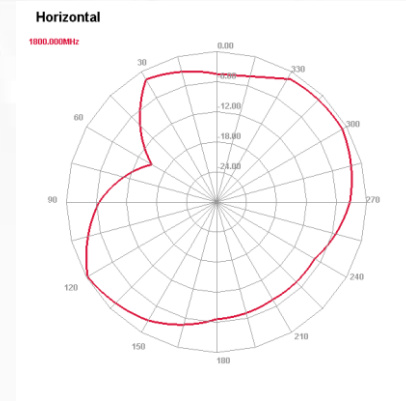

1800 MHz H plane

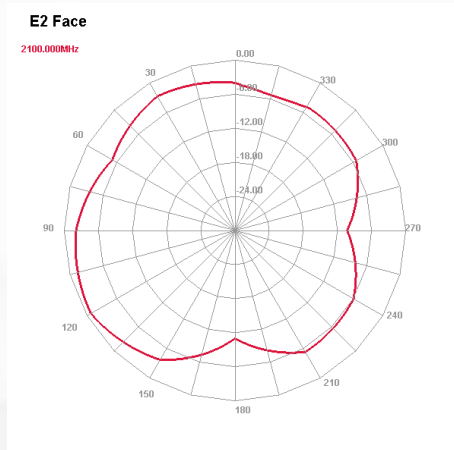

2100 MHz E plane

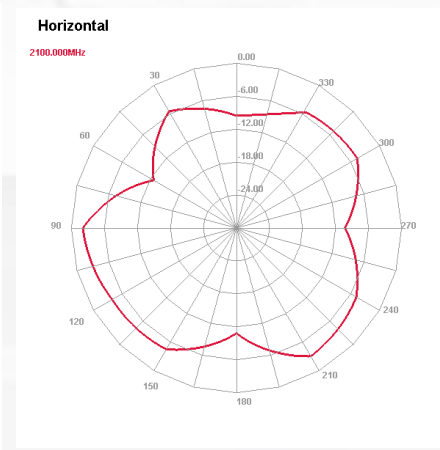

2100 MHz H plane

Maswell Cellular 5G/4G 8X8 MIMO Antenna Screw Mount IP67 UV stabilized L Plate Mount

AN_Master_Cubic-8C-LP

Radiation Pattern Antenna5

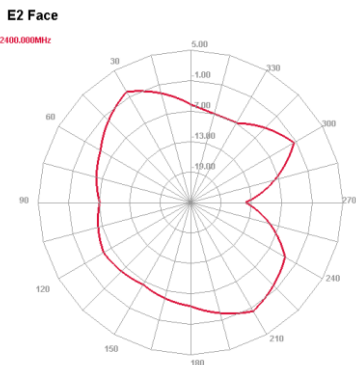

2400 MHz E plane

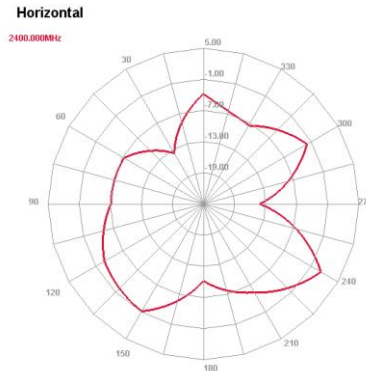

2400 MHz H plane

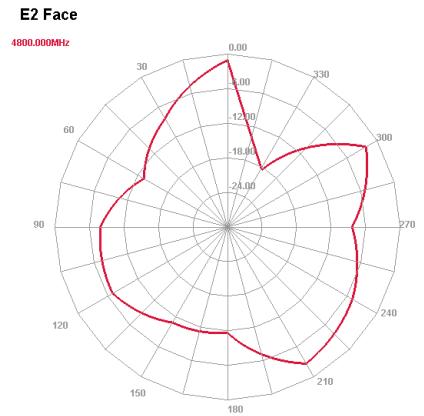

4800 MHz E plane

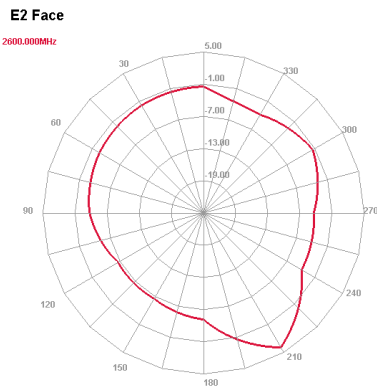

2600 MHz E plane

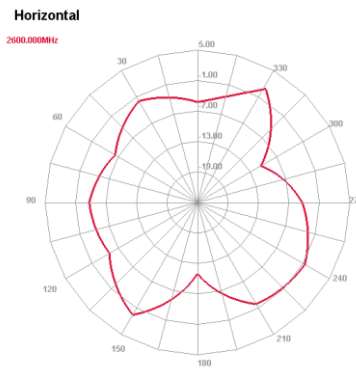

2600 MHz H plane

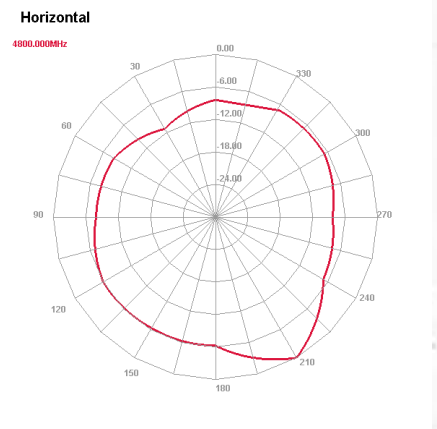

4800 MHz H plane

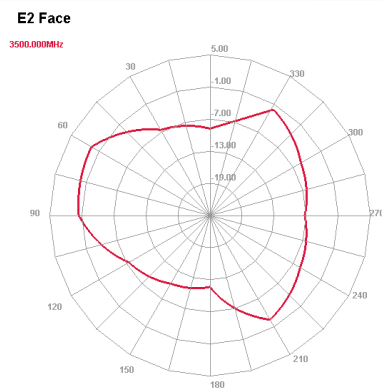

3500 MHz E plane

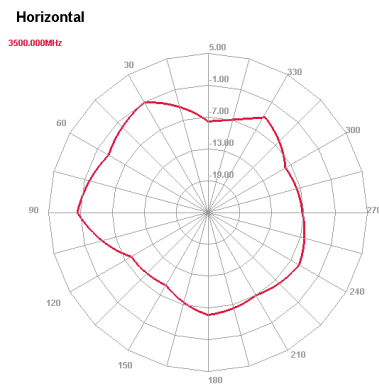

3500 MHz H plane

Maswell Cellular 5G/4G 8X8 MIMO Antenna Screw Mount IP67 UV stabilized L Plate Mount

AN_Master_Cubic-8C-LP

Radiation Pattern Antenna5

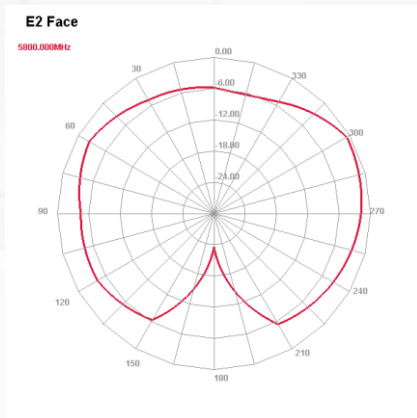

5800 MHz E plane

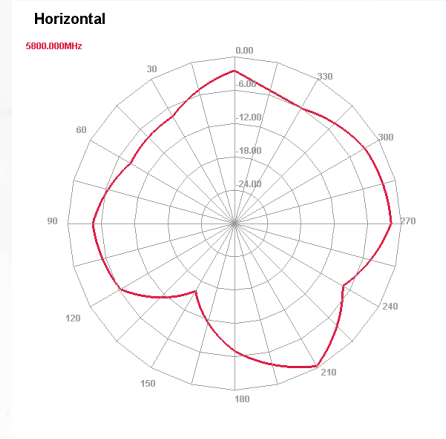

5800 MHz H plane

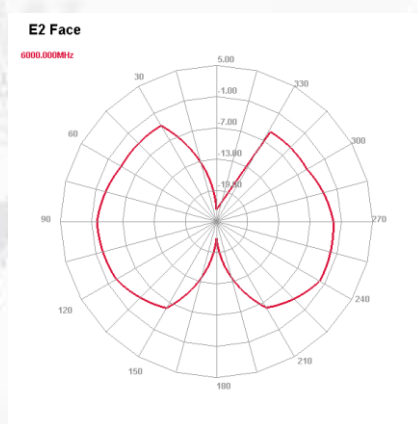

6000 MHz E plane

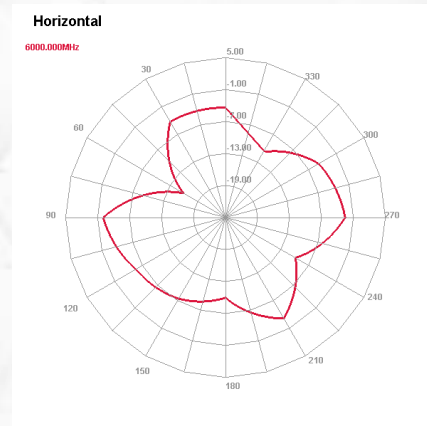

6000 MHz H plane

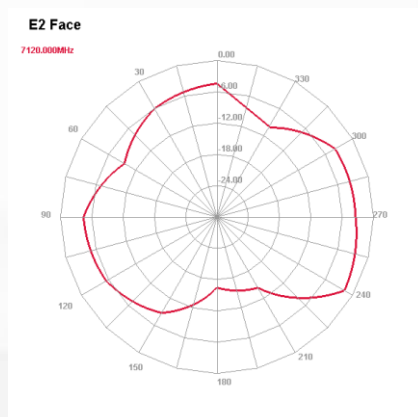

7120 MHz E plane

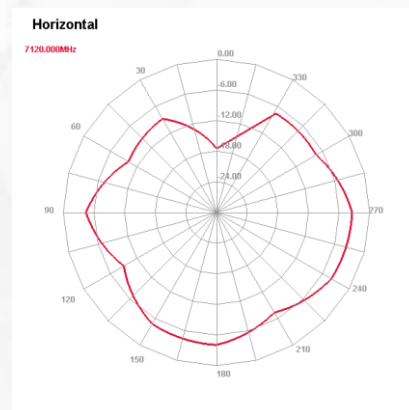

7120 MHz H plane

Maswell Cellular 5G/4G 8X8 MIMO Antenna Screw Mount IP67 UV stabilized L Plate Mount

AN_Master_Cubic-8C-LP

Radiation Pattern Antenna6

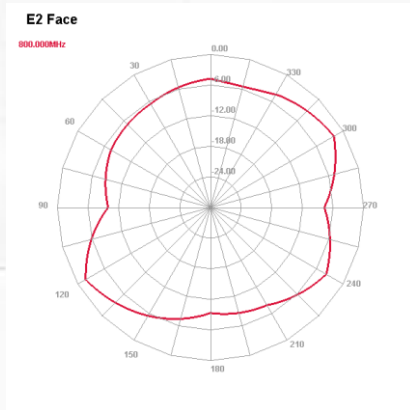

800 MHz E plane

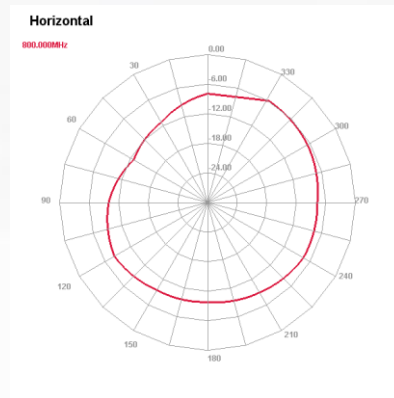

800 MHz H plane

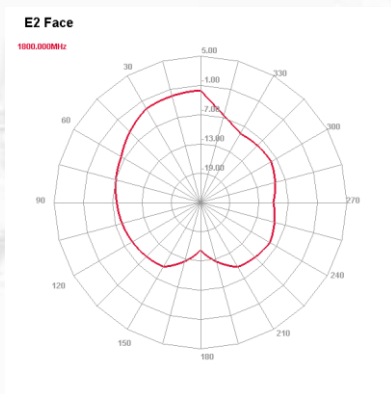

1800 MHz E plane

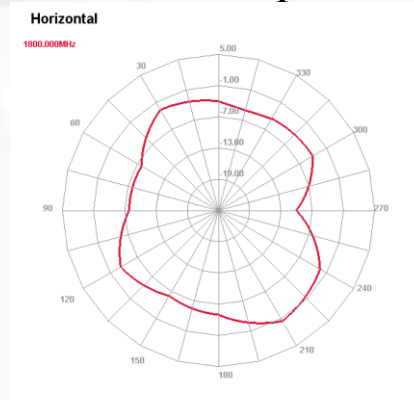

1800 MHz H plane

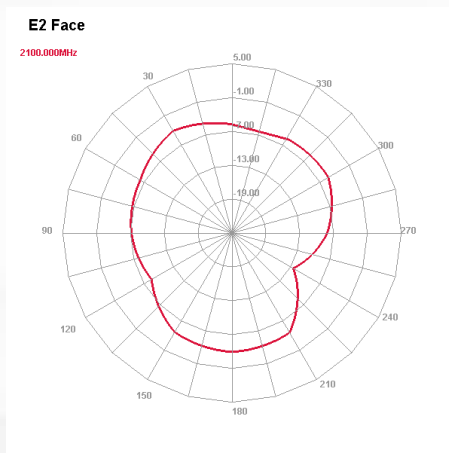

2100 MHz E plane

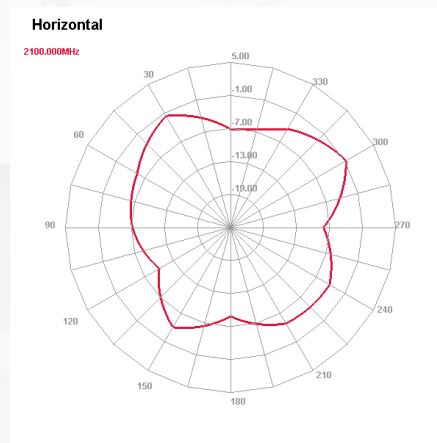

2100 MHz H plane

Maswell Cellular 5G/4G 8X8 MIMO Antenna Screw Mount IP67 UV stabilized L Plate Mount

AN_Master_Cubic-8C-LP

Radiation Pattern Antenna6

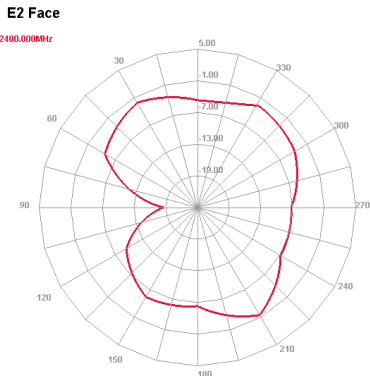

2400 MHz E plane

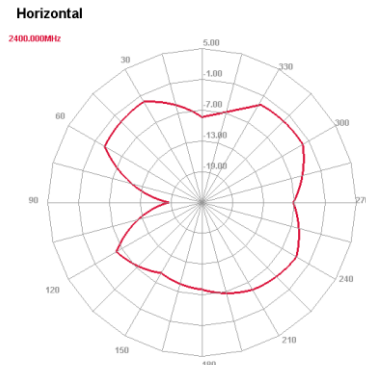

2400 MHz H plane

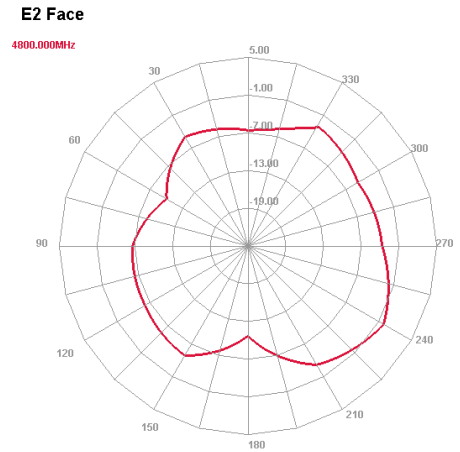

4800 MHz E plane

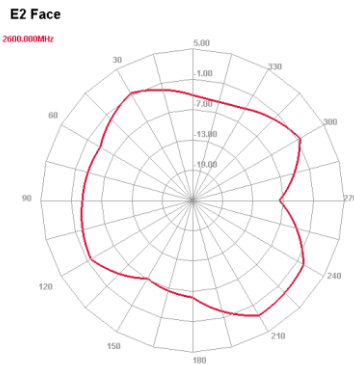

2600 MHz E plane

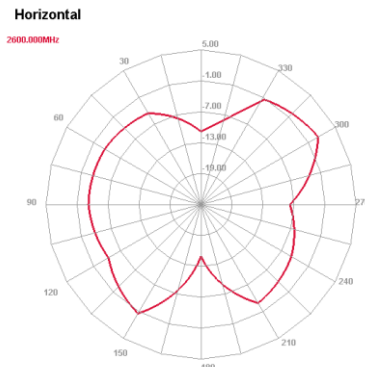

2600 MHz H plane

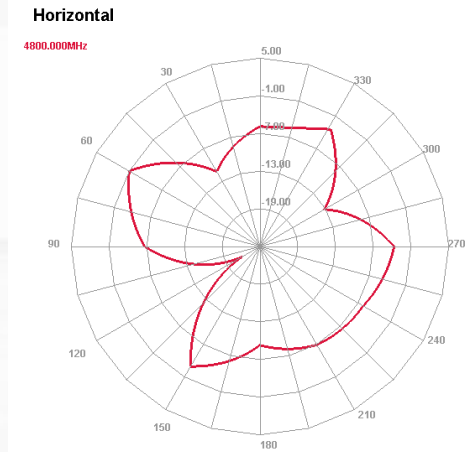

4800 MHz H plane

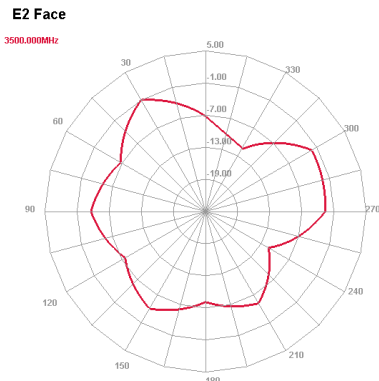

3500 MHz E plane

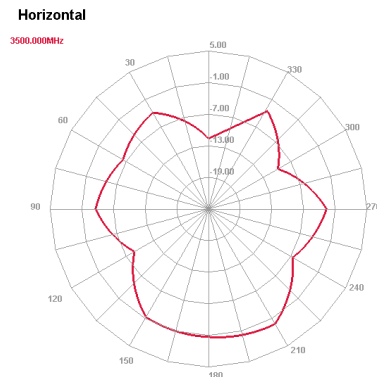

3500 MHz H plane

Maswell Cellular 5G/4G 8X8 MIMO Antenna Screw Mount IP67 UV stabilized L Plate Mount

AN_Master_Cubic-8C-LP

Radiation Pattern Antenna6

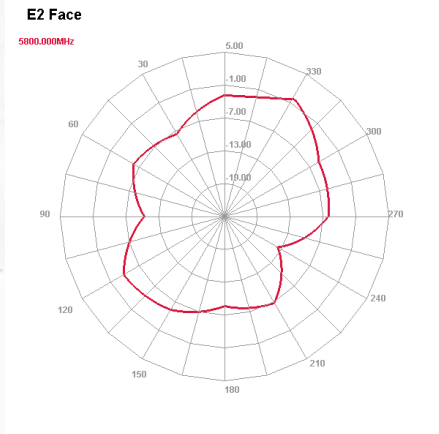

5800 MHz E plane

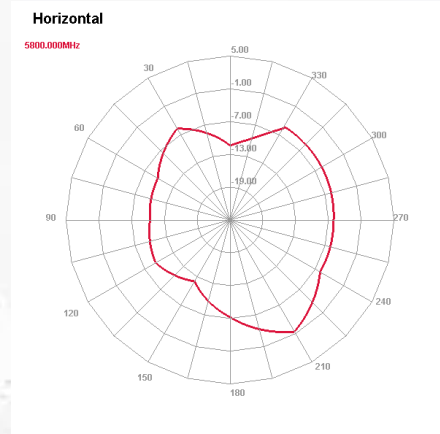

5800 MHz H plane

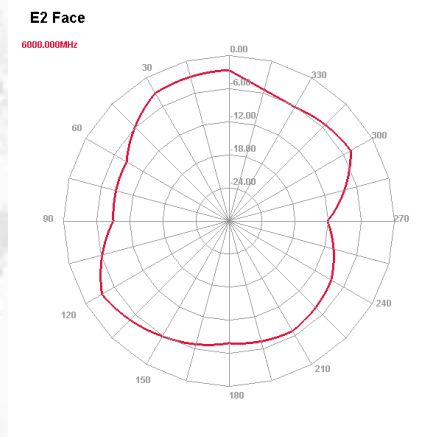

6000 MHz E plane

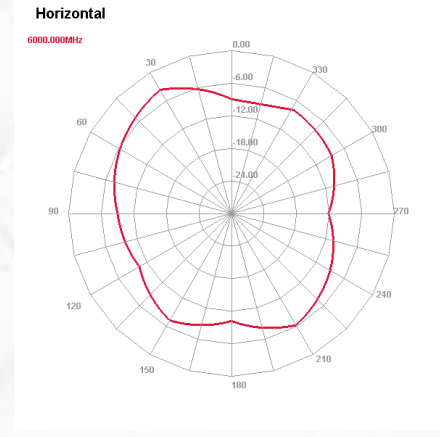

6000 MHz H plane

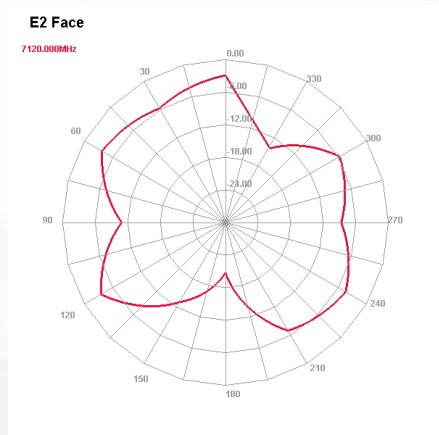

7120 MHz E plane

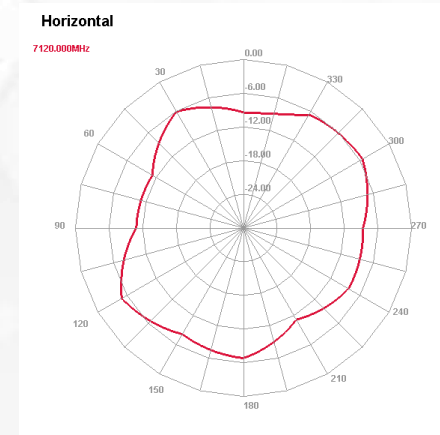

7120 MHz H plane

Maswell Cellular 5G/4G 8X8 MIMO Antenna Screw Mount IP67 UV stabilized L Plate Mount

AN_Master_Cubic-8C-LP

Radiation Pattern Antenna7

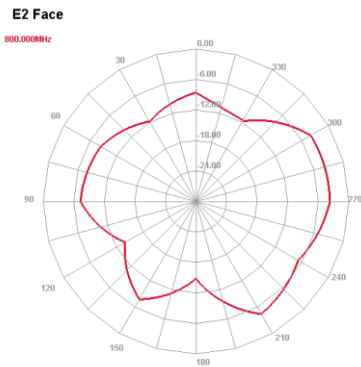

800 MHz E plane

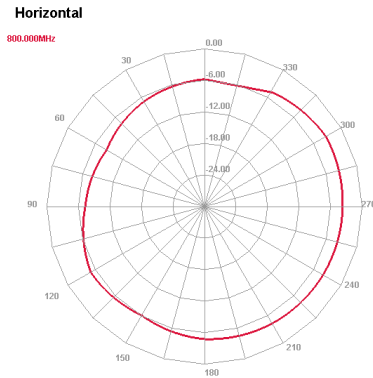

800 MHz H plane

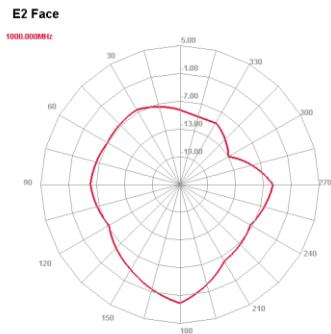

1800 MHz E plane

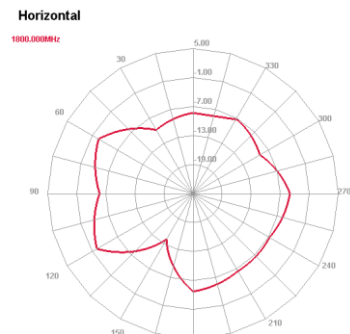

1800 MHz H plane

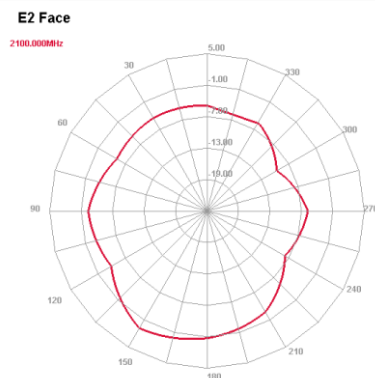

2100 MHz E plane

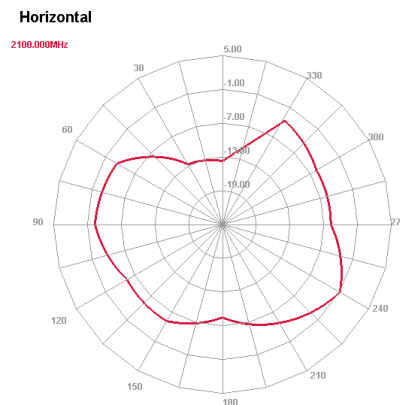

2100 MHz H plane

Maswell Cellular 5G/4G 8X8 MIMO Antenna Screw Mount IP67 UV stabilized L Plate Mount

AN_Master_Cubic-8C-LP

Radiation Pattern Antenna7

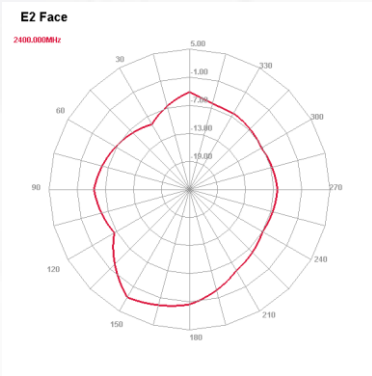

2400 MHz E plane

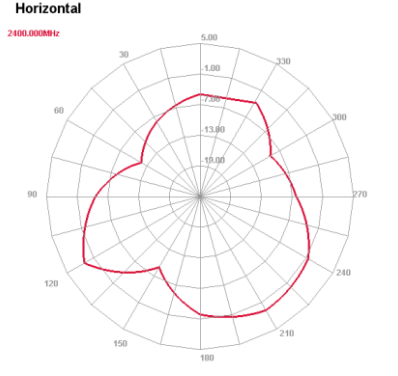

2400 MHz H plane

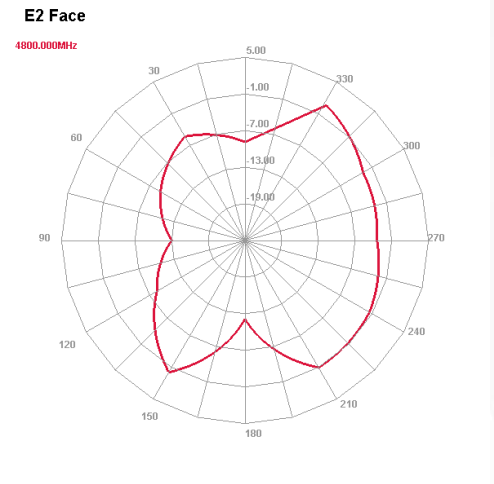

4800 MHz E plane

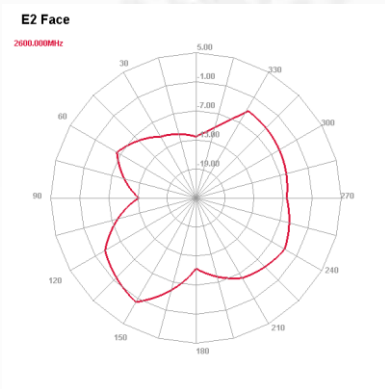

2600 MHz E plane

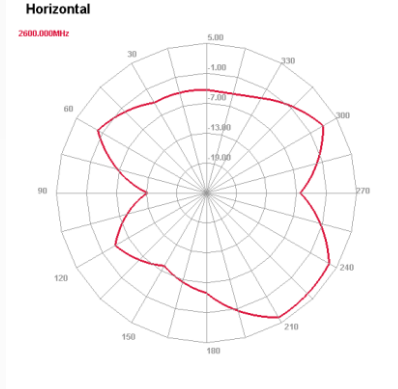

2600 MHz H plane

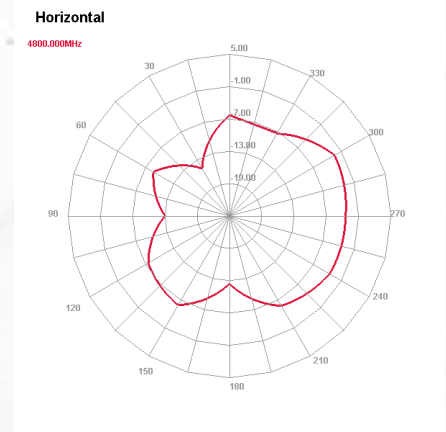

4800 MHz H plane

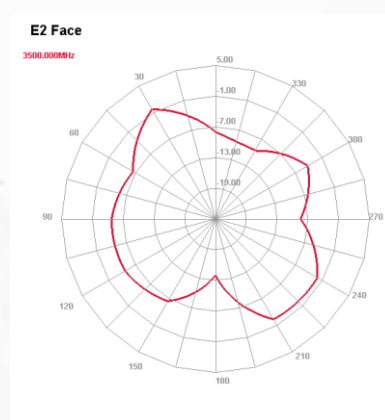

3500 MHz E plane

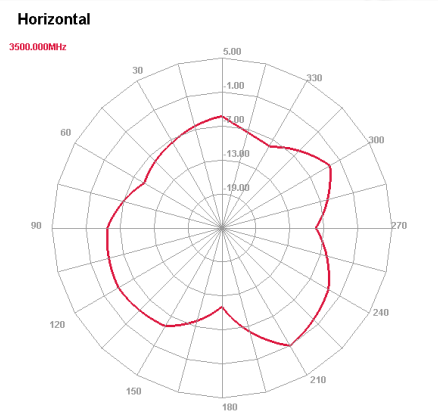

3500 MHz H plane

Maswell Cellular 5G/4G 8X8 MIMO Antenna Screw Mount IP67 UV stabilized L Plate Mount

AN_Master_Cubic-8C-LP

Radiation Pattern Antenna7

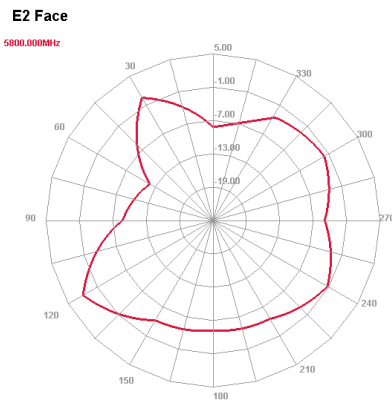

5800 MHz E plane

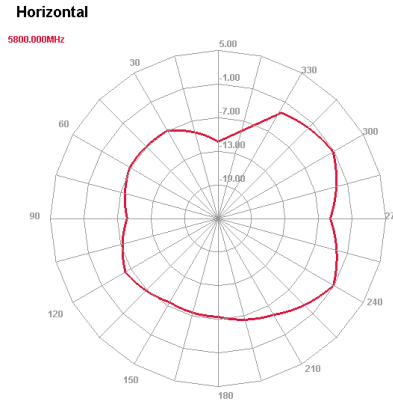

5800 MHz H plane

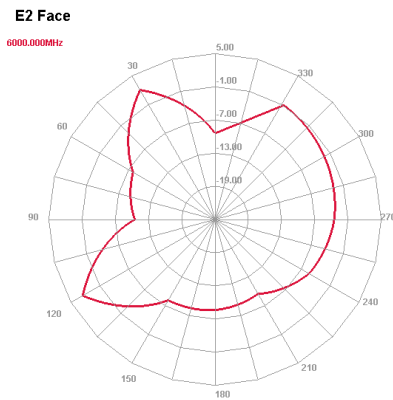

6000 MHz E plane

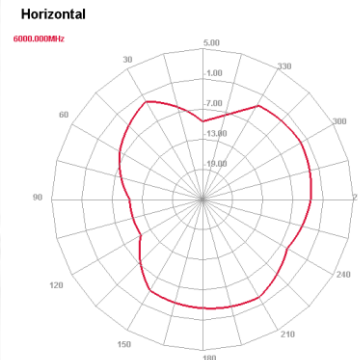

6000 MHz H plane

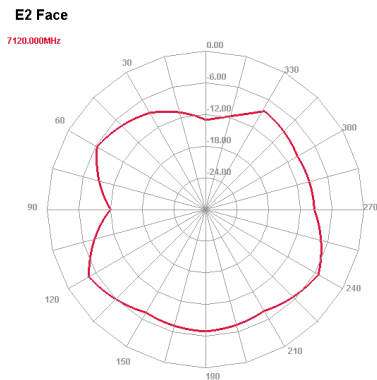

7120 MHz E plane

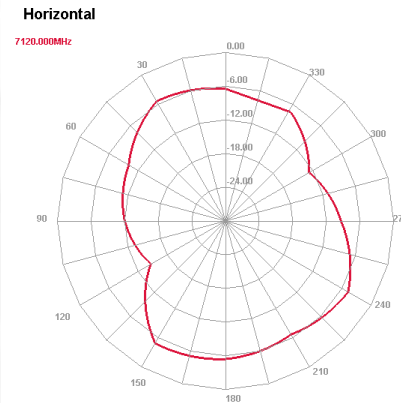

7120 MHz H plane

Maswell Cellular 5G/4G 8X8 MIMO Antenna Screw Mount IP67 UV stabilized L Plate Mount

AN_Master_Cubic-8C-LP

Radiation Pattern Antenna8

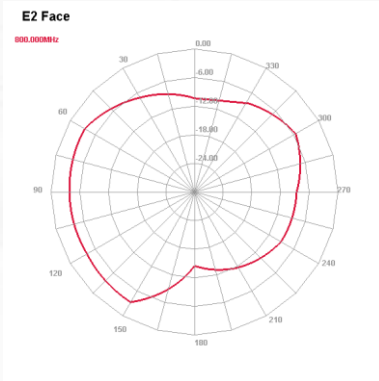

800 MHz E plane

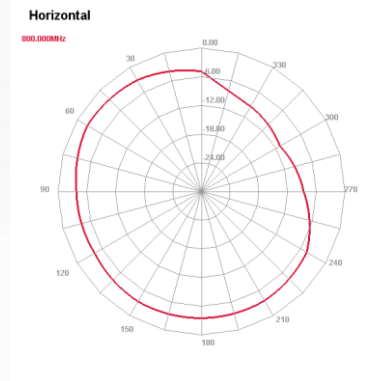

800 MHz H plane

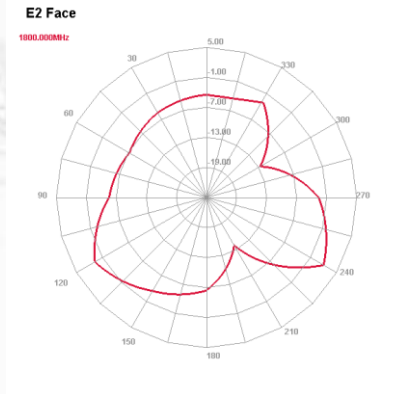

1800 MHz E plane

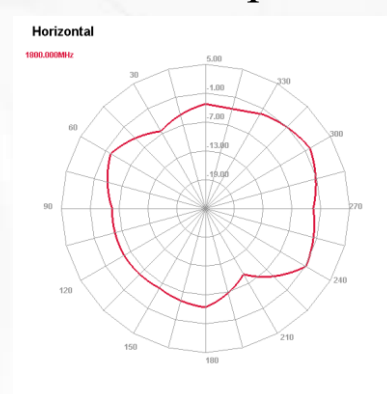

1800 MHz H plane

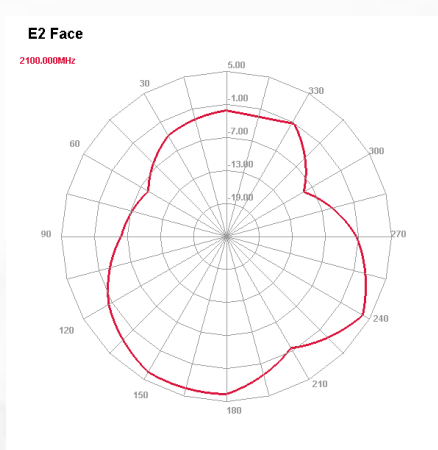

2100 MHz E plane

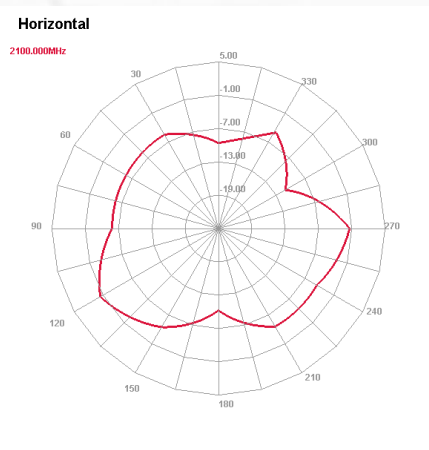

2100 MHz H plane

Maswell Cellular 5G/4G 8X8 MIMO Antenna Screw Mount IP67 UV stabilized L Plate Mount

AN_Master_Cubic-8C-LP

Radiation Pattern Antenna8

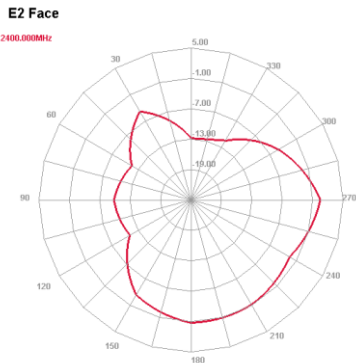

2400 MHz E plane

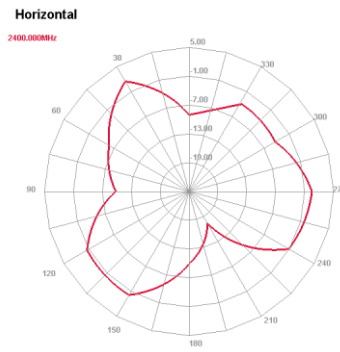

2400 MHz H plane

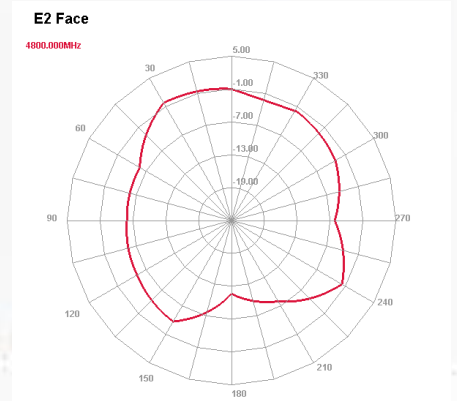

4800 MHz E plane

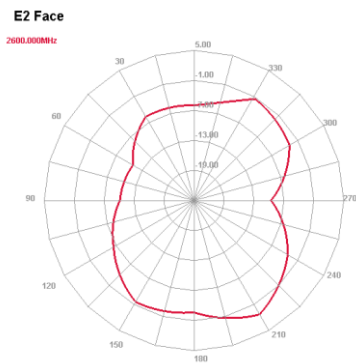

2600 MHz E plane

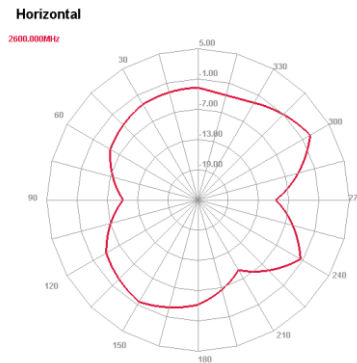

2600 MHz H plane

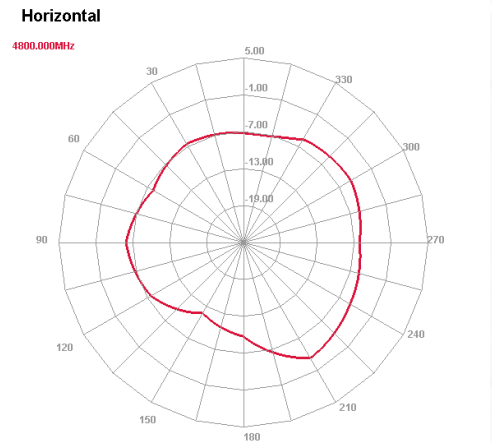

4800 MHz H plane

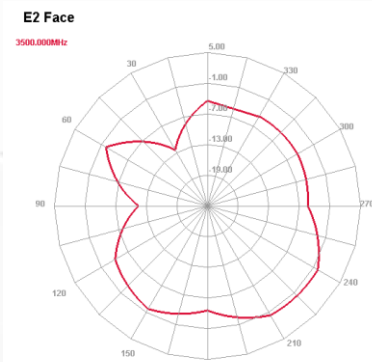

3500 MHz E plane

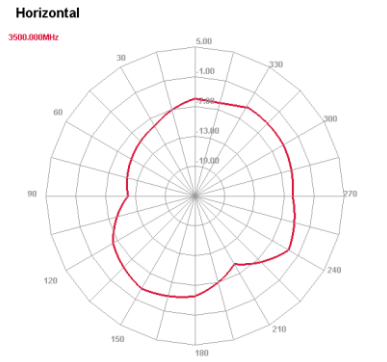

3500 MHz H plane

Maswell Cellular 5G/4G 8X8 MIMO Antenna Screw Mount IP67 UV stabilized L Plate Mount

AN_Master_Cubic-8C-LP

Radiation Pattern Antenna8

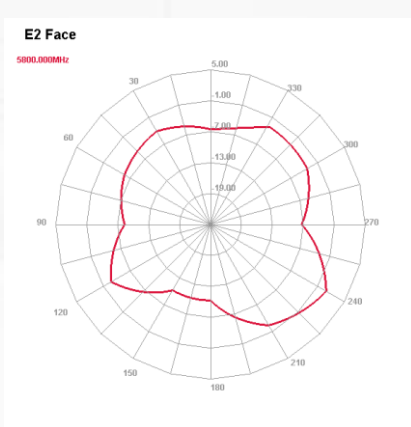

5800 MHz E plane

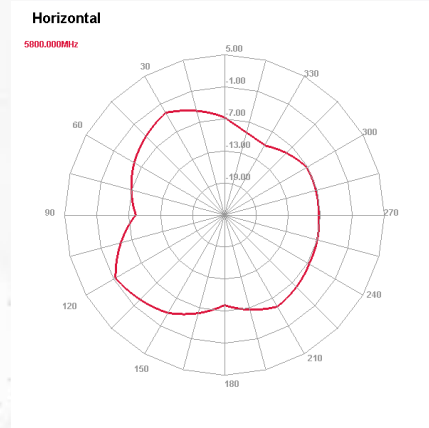

5800 MHz H plane

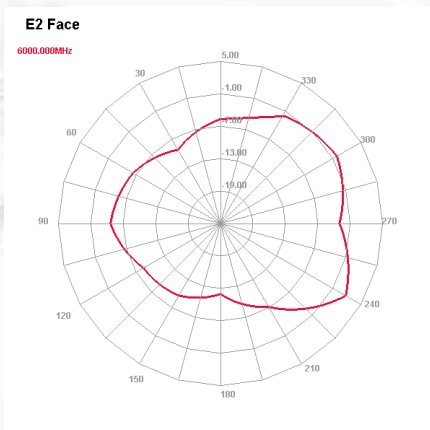

6000 MHz E plane

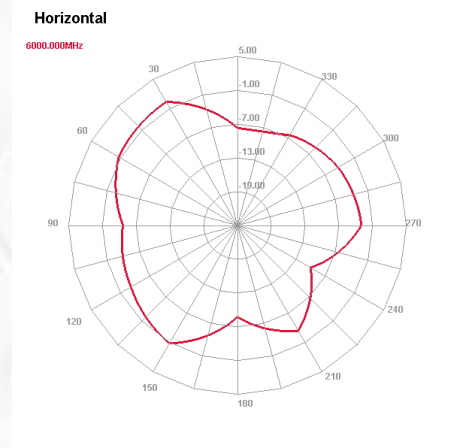

6000 MHz H plane

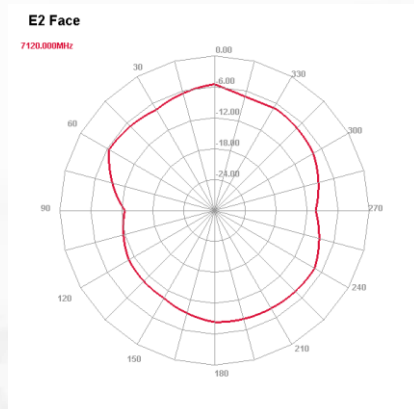

7120 MHz E plane

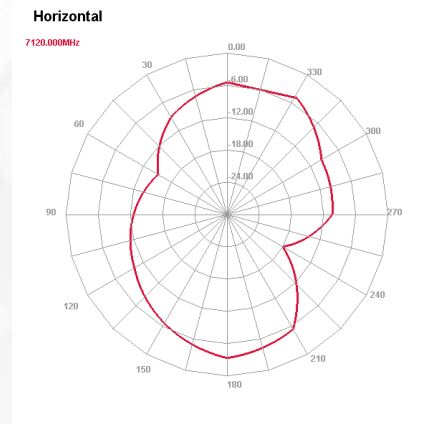

7120 MHz H plane